



VR1® Multi-Press
Medical Owner's Manual
Strength Systems
Part Number 13240-888-4 A



**VR1® Multi-Press
Medical Owner's Manual
Strength Systems
Part Number 13240-888-4 A**

NOTE: *This product meets or exceeds applicable ASTM, EN and Medical Standards.*

Cybex® and the Cybex logo are registered trademarks of Cybex International, Inc.
VR1® and its mark are registered trademarks of Cybex International, Inc.

DISCLAIMER: Cybex International, Inc., makes no representations or warranties regarding the contents of this manual. We reserve the right to revise this document at any time or to make changes to the product described within it without notice or obligation to notify any person of such revisions or changes.

© Copyright 2010, Cybex International, Inc. All rights reserved.

Printed in the United States of America.
10 Trotter Drive Medway, MA 02053 • 508-533-4300 • FAX 508-533-5183
www.cybexinternational.com • techhelp@cybexintl.com • techpubs@cybexintl.com • 13240-888-4 A • March 2010

Table of Contents

1 Safety

Safety	1-1
Safety Guidelines and Practices	1-3
Warning/Caution Decals	1-4
Regular Maintenance Activities.....	1-6
Using Proper Form	1-6

2 Exercises

Intended Use	2-1
Instructions	2-2

3 Customer Service

Contacting Service	3-1
--------------------------	-----

4 Maintenance

Daily Procedures	4-1
Weekly Procedures	4-2
Yearly Procedures	4-4
Environment.....	4-4
Storage	4-4

1 - Safety

Safety

This product complies with the European Medical Directive 93/42/EEC.

Read the Owner's manual carefully before using or servicing the equipment.

It is the responsibility of the facility owner and/or owner of the equipment to instruct users on proper operation of the equipment and review all labels.



Warning: Serious injury could occur if these safety precautions are not observed:

User Safety Precautions

- Follow advice of medical staff prior to beginning an exercise program.
- If a user has special needs (such as medical rehabilitation or disability) it is essential that the owner (person with legal responsibility) conducts a specific risk assessment to determine safe use and if necessary trained staff are available to supervise the activity.
- Injuries to health may result from incorrect or excessive training.
- Read and understand warning labels and user manual prior to exercising. Obtain instruction prior to use. 
- Keep body and clothing free from and clear of all moving parts.
- Inspect machine prior to use. **DO NOT** use if it appears damaged or inoperable.
- **DO NOT** attempt to fix a broken or jammed machine. Notify floor staff.
- Use this machine only for the intended use. **DO NOT** modify the machine.
- Be sure that the weight pin is completely inserted. Use only the pin provided by the manufacturer. If unsure, seek assistance.
- Never pin the weights in an elevated position. **DO NOT** use the machine if found in this condition. Seek assistance from floor staff.
- The intended use is not for children. Keep all children (12 and under) away. Teenagers (13 and over) must be supervised.
- **DO NOT** use if guards are missing or damaged.
- **DO NOT** use dumbbells or other incremental weights, except those provided by the manufacturer.
- Inspect all cables and belts and connections prior to use. **DO NOT** use if any components are worn, frayed or damaged.
- **DO NOT** remove any labeling from equipment. Replace any damaged labels.
- Stop exercising if you feel faint, dizzy or experience pain at any time while exercising and consult your physician.

Facility Safety Precautions

- Read the Owner's Manual carefully before assembling, servicing or using the equipment.
- Securely anchor each machine to the floor using the anchor holes provided in each machine.

NOTE: *Cybex is not responsible for the actual anchoring of equipment. Consult with a professional contractor.*

NOTE: *Use fasteners having a minimum of 2,220 newtons tensile capacity.*

NOTE: *If legs/frame does not contact surface, **DO NOT** pull down with anchors. Shim any leg or frame not in contact with surface using flat washers.*

- Make sure that each machine is set up and operated on a solid level surface. **Do not install equipment on an uneven surface.**
- Make sure that all users are properly trained on how to use the equipment and proper supervision based on individual indication is provided.
- Make sure there is enough room for safe access and operation of the equipment. **NOTE:** *At least one meter around machine when in exercise position.*
- Perform mandatory safety inspections. Perform regular maintenance checks on the equipment. Also pay close attention to all areas most susceptible to wear, including (but not limited to) cables, pulleys, belts and grips.
- Immediately replace worn or damaged components. If unable to immediately replace worn or damaged components, then remove from service until the repair is made.
- Use only Cybex supplied components to maintain/repair the equipment.
- Keep a repair log of all maintenance activities.
- Inspect all cables and belts and connections prior to use. **DO NOT** use if any components are worn, frayed or damaged.

NOTE: *It is the sole responsibility of the user/owner or facility operator to ensure that regular maintenance is performed.*

NOTE: *These machines do not have range limiting devices. Check range of movement of patient carefully before using equipment. Select resistance according to the individual indication. If you are unsure then start at lowest level. Perform exercises using smooth controlled movements.*

Safety Guidelines and Practices

Cybex recommends that all training equipment be used in a supervised area. It is recommended that the equipment be located in an access controlled area. Control is the responsibility of the owner. The extent of control is at the discretion of the owner.

It is the responsibility of the purchaser/user of Cybex products to read and understand the owner's manual, and warning labels; as well as instruct all individuals, whether end users or supervising personnel, on proper usage of the equipment.

Proper Usage:

Use machine only as described in the manual. Failing to follow proper instructions may result in injury.

Do Not Lean Against or Pull On the framework, weight stack, or any component, whether machine is at rest or in use. Inappropriate or improper use may result in injury to users or third parties (bystanders).

Do not use machine if it is not located on a solid level surface or is improperly installed.

Provide an adequate safety perimeter between the machine, walls and other equipment to ensure that the facility has the proper clearance for usage and training.

Securing Equipment:

The machine has holes in the feet, which allow for ease in anchoring to the floor. Cybex strongly recommends that, to eliminate rocking, tipping or falling over due to incorrect usage and misuse, equipment be secured to a solid, level surface.

1. The solid, level surface should not deviate more than 1/8" over a 10' distance or as defined and required by local building and architectural codes.
2. Anchoring of equipment must be completed by a qualified licensed contractor.
3. Anchoring holes are provided on the feet of the frame. All anchoring locations must be used when anchoring the equipment to the floor.
4. Due to the wide variation of flooring on which machines may be anchored or installed, verify anchoring method and anchoring fasteners with a qualified and licensed contractor.
5. A minimum pull out force of 220 lbs/100 kgs is required for each anchor position.
6. Do not use machine until it is properly anchored.

Maintenance:

Preventative maintenance allows proper equipment operation and reduces the risk of injury. Perform the maintenance requirements as specified in the manual.

Standard Compliance:

Cybex products meet or exceed applicable ASTM and EN Standards.



Warning/Caution Decals

Warning decals indicate a potentially hazardous situation, which, if not avoided, could result in death or serious injury.

Caution decals indicate a potentially hazardous situation, which, if not avoided, could result in minor or moderate injury.

The warning and caution decals are shown on the following page. The diagrams following the decals show where each decal is located.

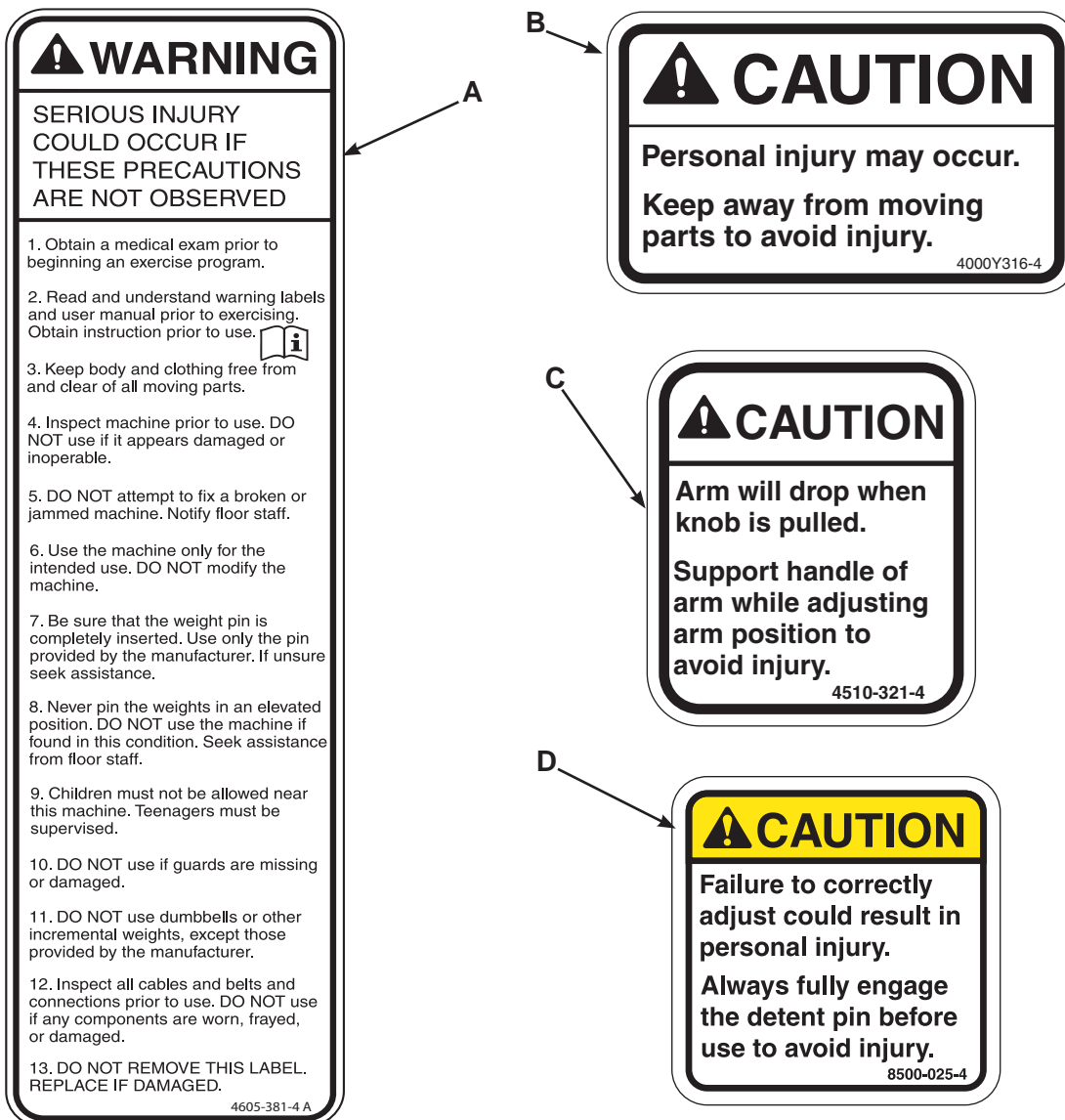

Multi-Press 13240

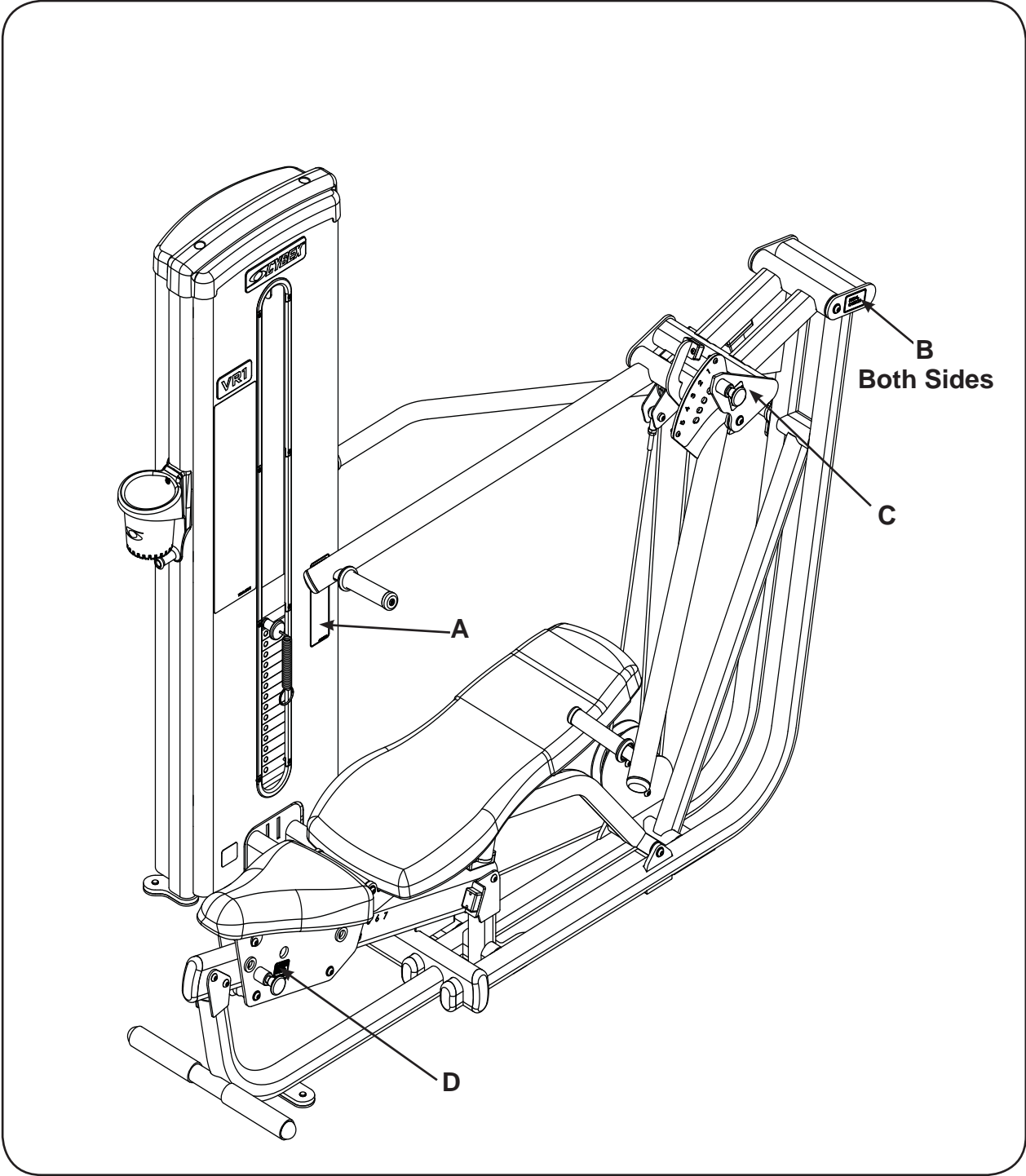

Description **Part No.**

- A. Warning Label.....4605-381-4
- B. Caution Decal..... 4000Y316-4
- C. Caution Decal..... 4510-321-4
- D. Caution Decal..... 8500-025-4

Regular Maintenance Activities

Preventative maintenance activities must be performed to maintain normal operation of your equipment. Keeping a log sheet of all maintenance actions will assist you in staying current with all preventative maintenance activities. The preventative maintenance actions are described in detail in Chapter 5. Briefly, they include:

Daily

1. Clean upholstery.

Weekly

1. Inspect all nuts and bolts for looseness. Tighten as required.
2. Inspect all cables and belts for damage or wear (see Chapter 5). *If a cable or belt is worn or damaged, immediately discontinue use until cable or belt has been replaced.*
3. Check for worn handles, worn snap links, and worn warning labeling. Replace all worn parts immediately.
4. Inspect for loose or worn grips. Replace all loose or worn grips immediately.
5. Inspect weight stacks for proper alignment and operation. Correct all improper alignment and operation issues immediately.
6. Lubricate guide rods using automotive engine oil only.

Yearly

1. Replace all cables and belts at least annually.

Using Proper Form

Before working out, read and understand the exercises located on the placard and in Chapter 2.

2 - Exercise

Intended Use

This equipment is suitable for treatment of patients with illness or injuries and for prevention. This equipment does not possess any measurement functions.

This equipment is only intended to be operated for use under the supervision of a physician, physiotherapist or physical therapist who has the requisite training and instruction.

The use of this equipment is the responsibility of the physician or trained medical expert.

MUSCLES USED

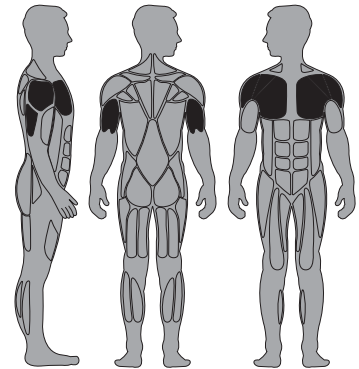

Pectoralis Major, Anterior Deltoid, Middle Deltoid, Triceps

START

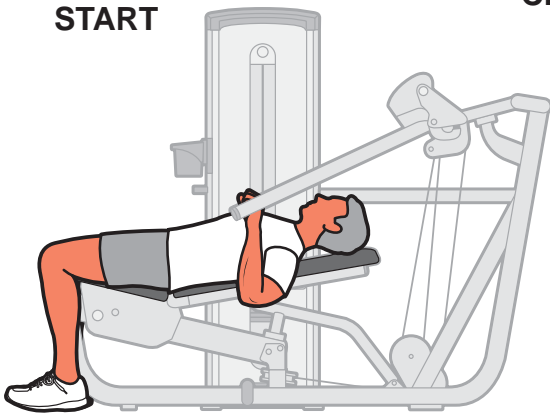

CHEST PRESS

FINISH

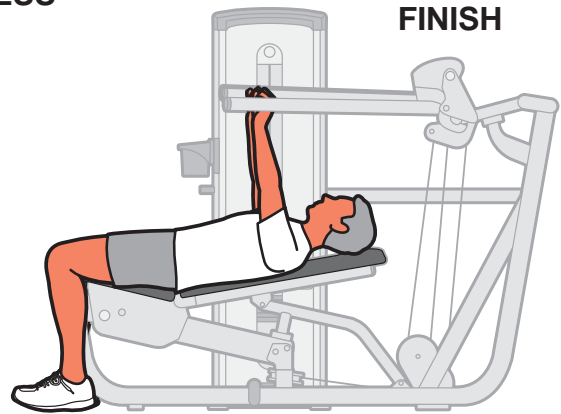

START

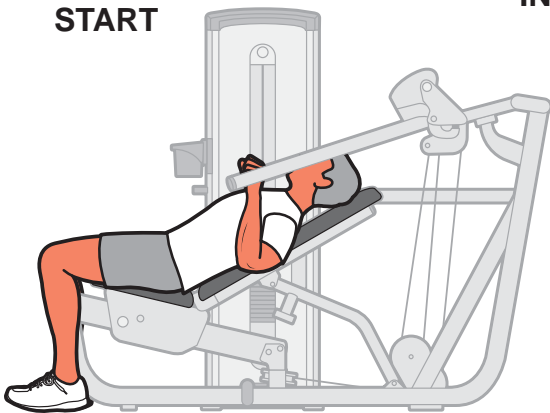

INCLINE PRESS

FINISH

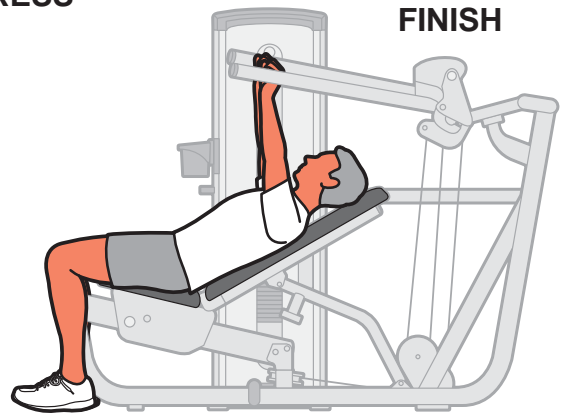

NOTE: Motions Developed: Horizontal Shoulder, Flexion, Shoulder Abduction, Elbow Extension

NOTE: All adjustment points on the machine have yellow handles or knobs.

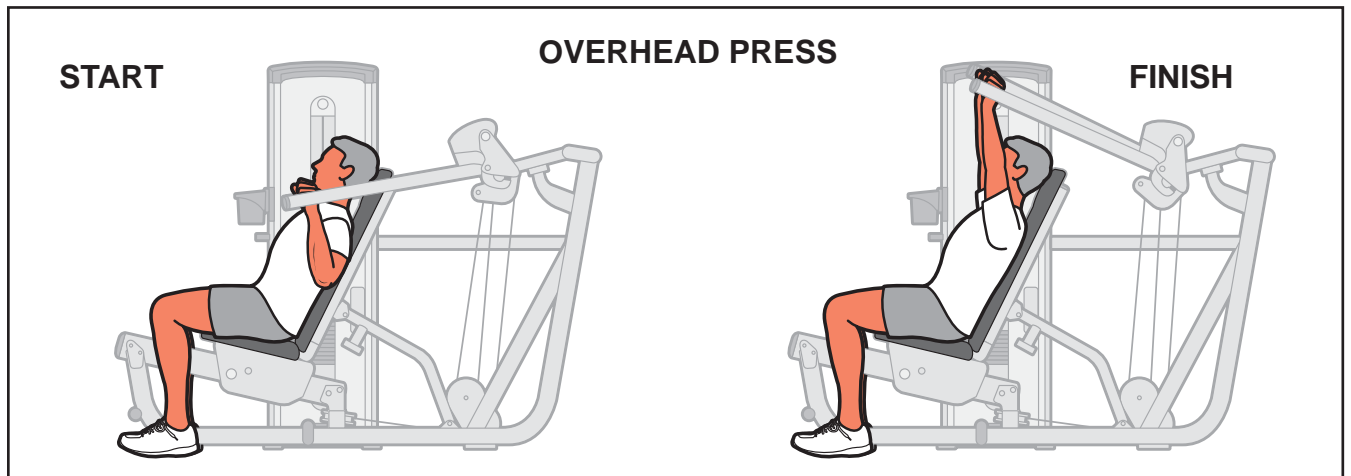

Instructions

Read and understand all instructions and warnings prior to using this machine. See Chapter 1, Safety, in the Owner's Manual or consult with floor staff.

Set Up

1. **Chest Press** - Adjust seat position to 1.

Adjust handle position to be slightly above chest.

2. **Incline Press** - Adjust seat position to 2, 3 or 4.

Adjust handle position to be slightly above upper chest.

3. **Overhead Press** - Adjust seat position to 5, 6, or 7.

Adjust handle position to be slightly above shoulders.

Movement

1. Push handle upward until arms are fully straightened.

Indications:

This machine is used for muscle training or physical rehabilitation and preventive health training only.

Equipment may only be used under supervision of an authorized trainer.

A patient needs to be capable of a full motion range.

The machine is not intended for any exercises other than the ones shown in the short instruction decal on the machine.

Contraindications:

The following conditions must be cleared by a physician beforehand: fractures, recent operations, severe osteoporosis with less than 80% bone density, acute herniated disc with surgical indication, tumors and severe circulatory or vascular illnesses and pulmonary functional disruptions, asthma, severe diabetes, pregnancy shortly before delivery, detached retina.

Cybox VR1 13240 Multi-Press Medical Owner's Manual

Equipment without motion limiters may only be used by patients capable of full range of motion. The equipment is not sterile and should not be used by patients with contagious diseases or open wounds.

If weakness, dizziness or pain occurs during training, stop the training and consult your physician.

Un-controlled or forced training can lead to pain/physical overloading. Only adjust the settings/weight intensity/number of repetitions after talking with your trainer.

Training may only be carried out after a prior instruction session by a qualified person.

This page intentionally left blank

3 - Customer Service

Contacting Service

Deutschland:

LMT Loctec AG
Daimlerstr. 10/1
D-78665 Frittlingen

Tel.: 07426 6004-0 oder
Tel.: 01805 292399

e-mail: info@lmt.ch

Schweiz und Lichtenstein:

LMT Leuenberger Medizintechnik AG
Industriestr. 19
CH-8304 Wallisellen

Tel.: 01/ 877 84 00

e-mail: lmt@lmt.ch

4 - Maintenance

All preventive maintenance activities must be performed on a regular basis. Performing routine preventive maintenance actions can aid in providing safe, trouble-free operation of all Cybox Strength Systems equipment.

NOTE: *Cybox is not responsible for performing regular inspection and maintenance actions for your machines. Instruct all personnel in equipment inspection and maintenance actions and also in accident reporting/recording. Cybox phone representatives are available to answer any questions or concerns that you may have.*



CAUTION: *Use only Cybox certified replacement parts when servicing. Failure to do so could result in personal injury.*

NOTE: *All inspections and repairs must be performed by trained service personnel only.*

Daily Procedures

1. Upholstery - Wipe down all upholstery daily using water based disinfection solution.

2. Frames - Wipe down all frames using a mild solution of warm water and car wash soap. Be sure to dry thoroughly. **AVOID** acid or chlorine based cleaners and also cleaners containing abrasives as these could scratch or damage the equipment.

3. Chrome - Clean chrome tubes, first using chrome polish and then using a car wax seal. Neutral cleaners with a pH between 5.5 and 8.5 are recommended. Be sure to dry thoroughly. **AVOID** acid or chlorine based cleaners and also cleaners containing abrasives as these could scratch or damage the equipment.

4. Guidelines for cleaning front panel:

- Use clean soft cloths or sponges for application of cleaners and again for washing and rinsing.
- Follow up the application with warm water rinse.
- Don't use abrasives or high alkaline cleaners.
- Don't leave cleaners on for long periods, wash immediately.
- Don't apply cleaners in direct sunlight or at elevated temperatures.
- Don't use scrapers, squeegees or razors.
- Don't clean with gasoline.

Weekly Procedures

1. Check all nuts and bolts for looseness. Tighten as required.
2. Inspect all cables for wear or damage and proper tension. When inspecting cables, run fingers on the cable, paying particular attention to bends in cable and attachment points.



WARNING: Replace all worn cables immediately. The following conditions may indicate a worn cable:

- A tear or crack in the cable sheath that exposes the cable. See Figure 1.

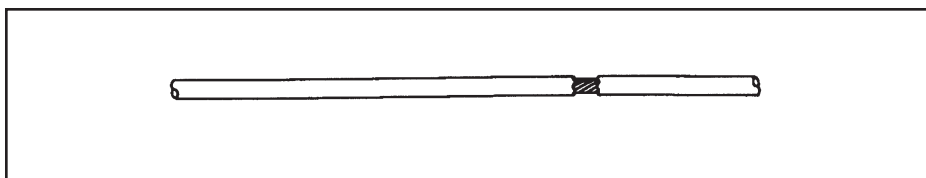

Figure 1

- A kink in the cable. See Figure 2.

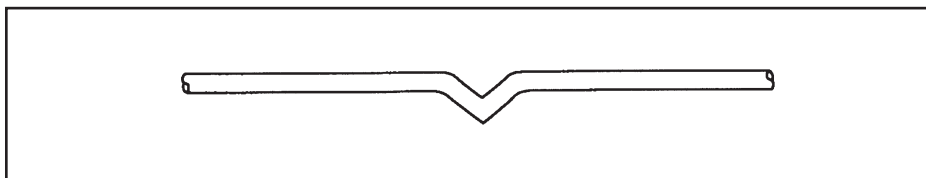

Figure 2

- A curled sheath. See Figure 3.

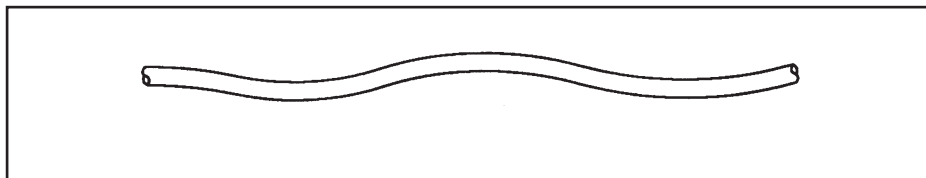

Figure 3

- "Necking", a stretched cable sheath. See Figure 4.

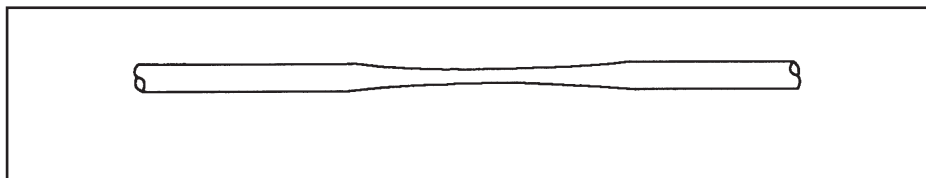

Figure 4

3. Inspect bars and handles for wear, paying particular attention to tab area connection points.

Replace all worn handles immediately.



CAUTION: Replace all worn handles immediately. Do not use if less than 1/8" of material remains to the edge. See Figure 5.

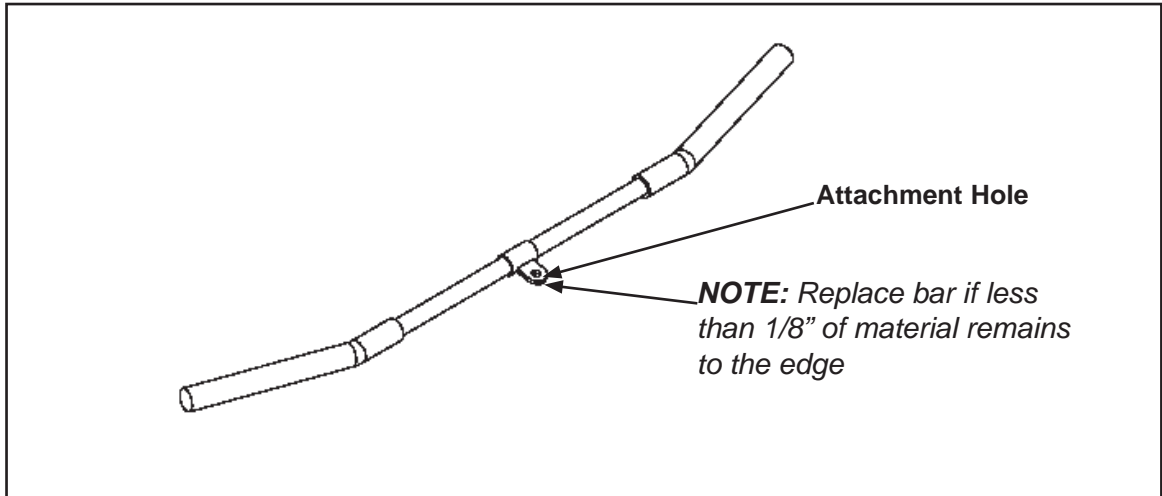

Figure 5

4. Inspect snap links for proper latching (indicates wear)

Replace all worn snap links immediately.

5. Inspect for loose or worn grips.

Replace all loose or worn grips immediately.

6. Inspect all labeling for readability. This includes instructional placards, warning and caution decals.

Replace all worn labeling immediately.

7. Inspect all weight stacks for proper alignment and operation.

Correct all improper alignment and operation issues immediately.

8. Wipe Weight Stack Guide Rods clean over entire length. Lubricate with a light coat of medium weight automotive engine oil.

Yearly Procedures

1. Replace all cables at least annually.

Environment

Static Electricity - Depending upon where you live, you may experience dry air, causing a common experience of static electricity. This may be especially true in the winter time. You may notice a static build-up just by walking across a carpet and then touching a metal object. The same can hold true while working out on your unit. You may experience a shock due to the build-up of static electricity on your body and the discharge path of the unit. If you experience this type of situation, you may want to increase the humidity to a comfortable level through the use of a humidifier.

Humidity - The unit is designed to function normally in an environment with a relative humidity range of 30% to 75%.

NOTE: *Do not install or use the unit in an area of high humidity, such as in the vicinity of a steam room, sauna, indoor pool or outdoors. Exposure to extensive water vapor, chlorine and/or bromine could adversely affect the electronics as well as other parts of the machine.*

Temperature - The unit is designed to function normally in an environment with an ambient temperature range of 50° F (10° C) to 104° F(40° C) degrees.

Storage

Humidity - The unit can be shipped and stored in an environment with a relative humidity range of 10% to 90%.

NOTE: *Do not store the unit in an area of high humidity, such as in the vicinity of a steam room, sauna, indoor pool or outdoors. Exposure to extensive water vapor, chlorine and/or bromine could adversely affect the electronics as well as other parts of the machine.*

Temperature - The unit can be shipped and stored in an environment with an ambient temperature range of 32° F (0° C) and 140 F (60° C) degrees.



10 Trotter Drive Medway, MA 02053 • 508-533-4300 • FAX 508-533-5183
www.cybexinternational.com • techhelp@cybexintl.com