

OWNERS MANUAL

HOIST

HF4363

CALF RAISE

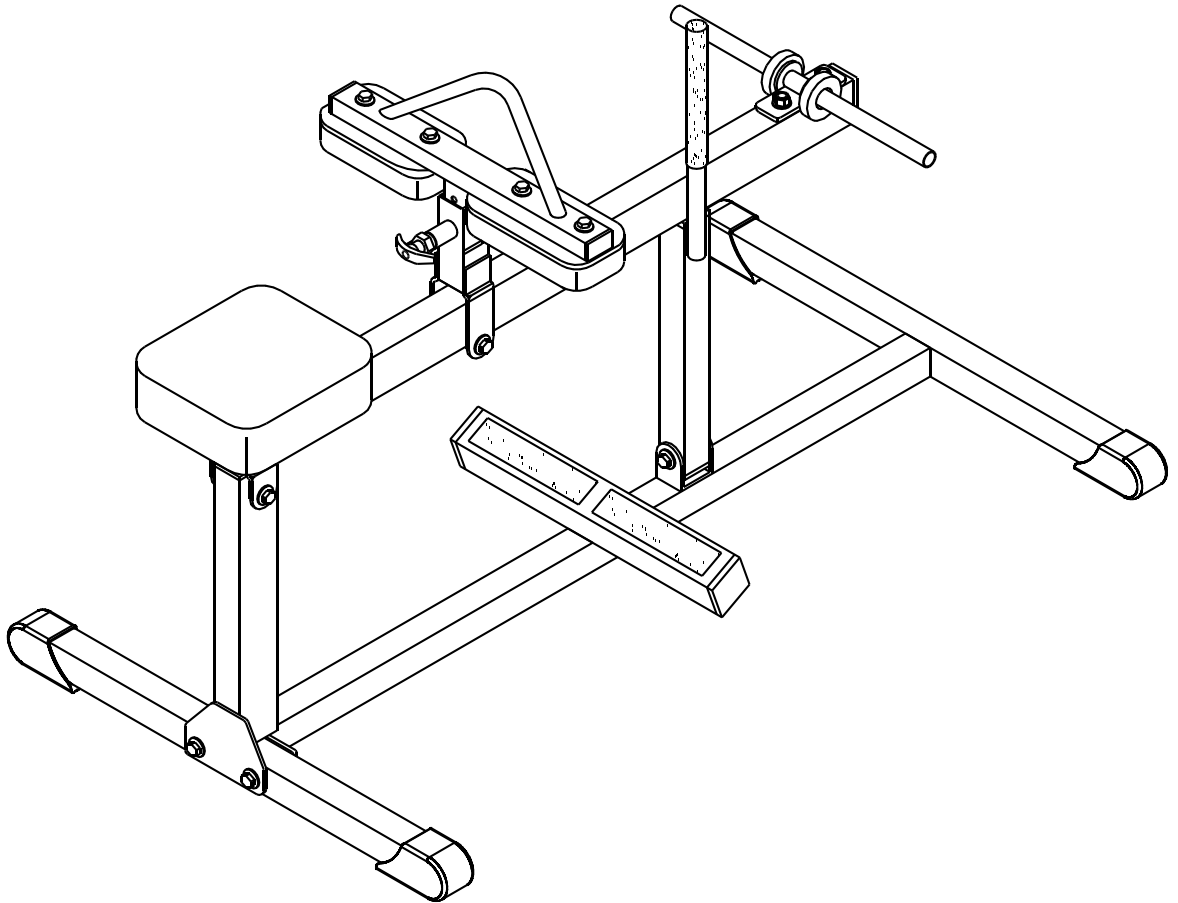

Note: Both Serial Number and Model Number are Required when Ordering Parts

RECORD SERIAL NUMBER HERE

CATALOG NUMBER

Customer Service

(800) 548-5438

(858) 578-7676

Fax

(858) 578-9558

ASSEMBLY MANUAL

CONTENTS

<i>INSTRUCTIONS</i>	2
<i>PRE-INSTALLED PARTS</i>	3
<i>FRAME ASSEMBLY</i>	4
<i>PARTS LIST</i>	5
<i>HARDWARE LIST</i>	6
<i>DECAL REFERENCE</i>	7
<i>BOLT SIZING CHART</i>	8
<i>WASHER SIZING CHART</i>	9
<i>MAINTENANCE SCHEDULE</i>	10
<i>GENERAL MAINTENANCE</i>	11
<i>LIMITED WARRANTY</i>	13

ASSEMBLY M A N U A L

I N S T R U C T I O N S

Before beginning assembly please take the time to read the instructions thoroughly. Please use the various lists in this manual to make sure that all parts have been included in your shipment. When ordering use the part number and description from the lists. Use only Hoist replacement parts when servicing. Failure to do so will void your warranty and could result in personal injury.

Hoist equipment is designed to provide the smoothest, most effective exercise motion possible. After assembly, you should check all functions to ensure correct operation. If you experience problems, first recheck the assembly instructions to locate any possible errors made during assembly. If you are unable to correct the problem, call your authorized Hoist dealer. Be sure to have your serial number and this manual when calling. When all parts have been accounted for, continue on .

T O O L S R E Q U I R E D

Socket Wrench

7/16", 1/2", 9/16", and 3/4" Sockets

Crescent Wrench

Rubber Mallet

Tape Measure

ASSEMBLY MANUAL

PRE-INSTALLED PARTS

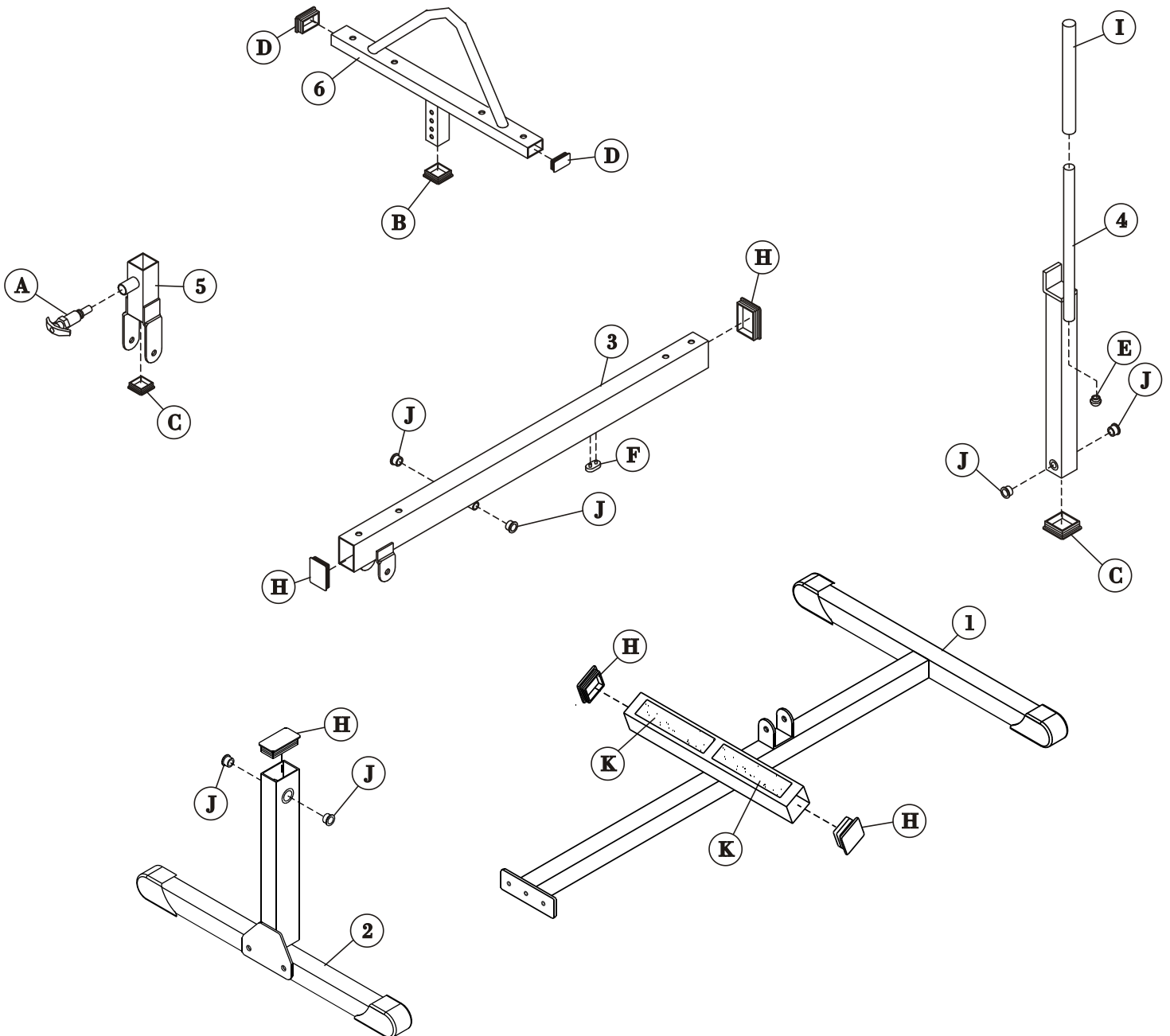

ASSEMBLY MANUAL

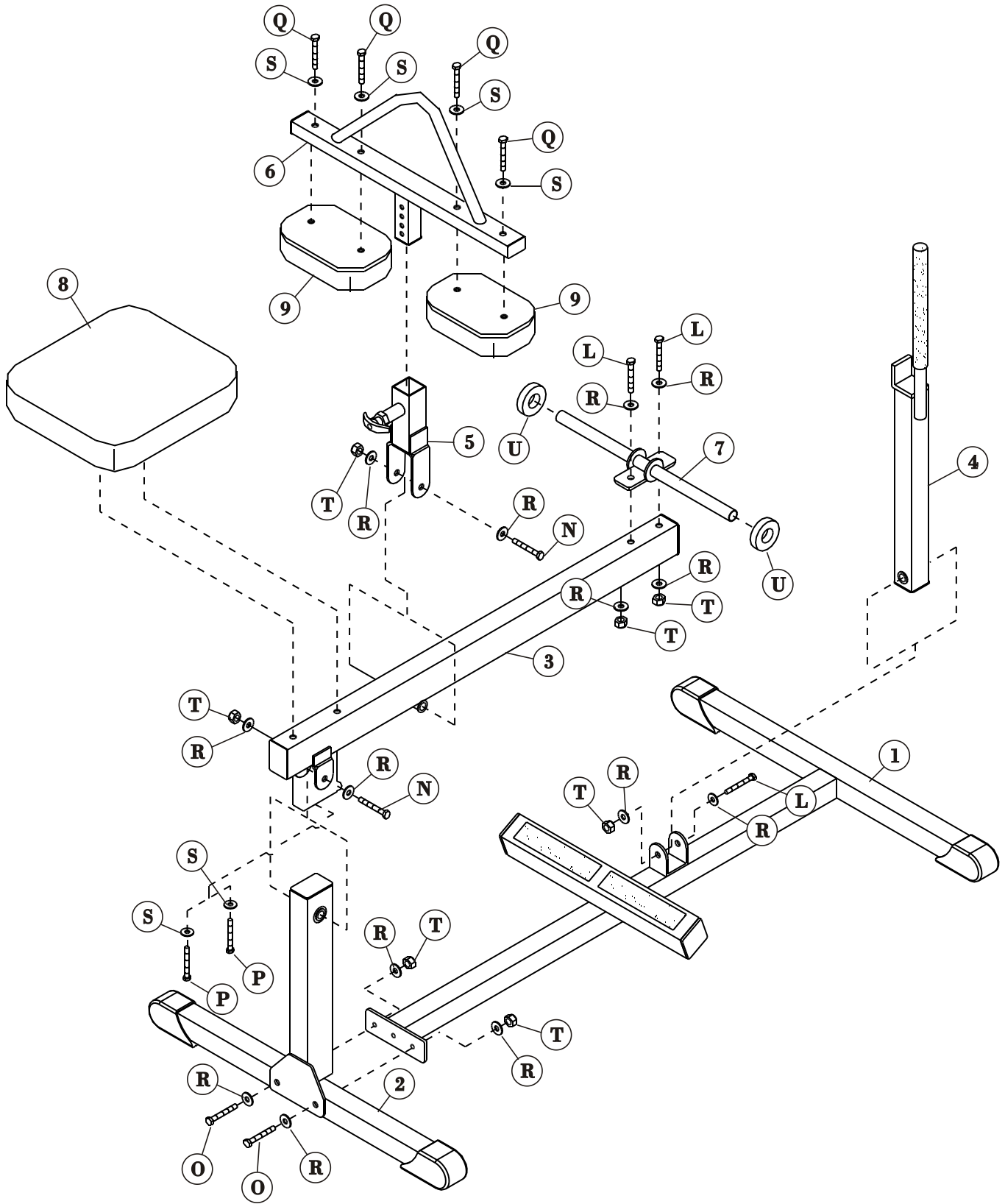

ASSEMBLY MANUAL

PARTS LIST

<u>Key #</u>	<u>Qty</u>	<u>Part Number</u>	<u>Description</u>
1	1	26-STD-04-0747	BASE FRAME
2	1	26-STD-04-0748	PIVOT MOUNT
3	1	26-STD-04-0750	LEVERAGE ARM
4	1	26-STD-04-0749	ARM REST
5	1	26-STD-04-0751	KNEE PAD ADJUSTER
6	1	26-STD-04-0752	KNEE PAD MOUNT
7	1	26-STD-04-0753	WEIGHTS MOUNT
8	1	26-STD-07-0103A	SEAT PAD
9	2	26-STD-07-0103B	KNEE PAD

ASSEMBLY M A N U A L

HARDWARE LIST

<u>Key #</u>	<u>Qty</u>	<u>Part Number</u>	<u>Description</u>
A	1	26-STD-11-0018	Pull Pin (for Knee Pad Adjuster)
B	1	26-STD-06-0074	Endcap - 45mm x 45mm
C	2	26-STD-06-0075	Endcap - 50mm x 50mm
D	2	26-STD-06-0055	Endcap - 25mm x 50mm
E	1	26-STD-06-0066	Round Endcap - 1" Dia.
F	1	26-STD-06-0129	Bumper - 45 L x 25 W x 8.0t
H	5	26-STD-06-0108	Endcap - 50mm x 75mm
I	1	19-GRP-205CLOSED	Comfort Grip - ID 25.4mm x 205mm Lg.
J	6	26-STD-08-0026	Flange Oilite- 19.3mm O.D. x 12.8mm I.D. x 18mm H
K	2	26-STD-10-0091	Non-Skid Rubber Strip (Black) - 50mm W x 203mm L x 1.2mm t
L	3	11-HEX-124	Hex Bolt- 1/2"-13UNC x 4" L
N	2	11-HEX-12312	Hex Bolt- 1/2"-13UNC x 3 1/2" L
O	2	11-HEX-12314	Hex Bolt- 1/2"-13UNC x 3 1/4" L
P	2	11-HEX-516334	Hex Bolt- 5/16"-18UNC x 3 3/4" L
Q	4	11-HEX-516214	Hex Bolt- 5/16"-18UNC x 2 1/4" L
R	14	13-FLT-12SAE	Flat Washer - 1/2" SAE
S	6	13-FLT-516USS	Flat Washer - 5/16" USS
T	7	12-LOK-12	Nylon Locknut - 1/2"
U	2	26-STD-06-0153	Bumper- 63mm O.D.x 26mm I.D. x 16mm h

ASSEMBLY MANUAL

DECAL REFERENCE

These decals have been attached to this piece of equipment to provide information regarding operation, safety and maintenance. Before use, take the time to read these decals.

! WARNING

USE ONLY GENUINE HOIST REPLACEMENT PARTS. FAILURE TO DO SO WILL VOID WARRANTY AND COULD RESULT IN PERSONAL INJURY OR EVEN DEATH. THERE IS A RISK ASSUMED BY INDIVIDUALS WHO USE THIS TYPE OF EQUIPMENT. TO MINIMIZE THE RISK ALWAYS FOLLOW THESE SIMPLE RULES.

1. READ & UNDERSTAND ALL ENCLOSED INSTRUCTIONS before using this equipment.
2. INSPECT EQUIPMENT BEFORE EACH USE. Replace all parts at the first signs of wear or damage. If in doubt about a certain part, DO NOT use the equipment until the part is replaced. Failure to replace worn or damaged parts may result in injury.
3. FOLLOW ROUTINE MAINTENANCE SCHEDULE
4. CONSULT YOUR PHYSICIAN BEFORE STARTING ANY EXERCISE PROGRAM. Warm up properly before engaging in weight resistance training. Stop exercising if you feel faint or dizzy.
5. TO PREVENT THE POSSIBILITY OF SERIOUS INJURY, KEEP CLEAR OF ALL MOVING PARTS. Do not attempt to free any jammed part by yourself. Obtain assistance in order to avoid possible injury.
6. Take your time and do not rush the exercise. Practice proper breathing, NEVER hold your breath.
7. CHILDREN SHOULD NOT BE ALLOWED TO USE THIS EQUIPMENT. To avoid possible injury, children should be kept at a safe distance when this equipment is in use. Teenagers should not use this equipment without adult supervision.
8. CALL YOUR AUTHORIZED HOIST DISTRIBUTOR if you have any questions on the proper use or maintenance of this equipment.

021-0003135

NOTICE		Daily	Weekly	Monthly	6 Months	Yearly
COMMERCIAL MAINTENANCE						
Inspect; Links, Pull Pins, Snap Locks, Swivels, Weight Stack Pins	x					
Clean; Upholstery	x					
Inspect; Cables or Belts and their tension	x					
Inspect; Accessory Bars and Handles	x					
Inspect; All Decals	x					
Inspect; All nuts and Bolts Tighten if Needed.	x					
Inspect; Anti-Skid Surfaces	x					
Clean & Lubricate; Guide Rods with a Teflon (PTFE) based lubricant (Superlube)			x			
Lubricate; Seat Sleeves, Turcite Bushings, Linear Bearing			x			
Clean & Wax; All Glossy Finishes				x		
Repack with Grease Linear Bearings				x		
Replace; Cables, Belts and Connecting Parts.						x

021-0003008



021-0003093

1-800-548-5438
www.hoistfitness.com
SERIAL # 00-00-000000

SERIAL # DECAL



021-0003221

SERIAL # DECAL ; Always refer to the number shown on your piece of equipment when talking to customer service or ordering parts.

ASSEMBLY

C A T A L O G

B O L T S I Z I N G C H A R T

5/16" HEX BOLT

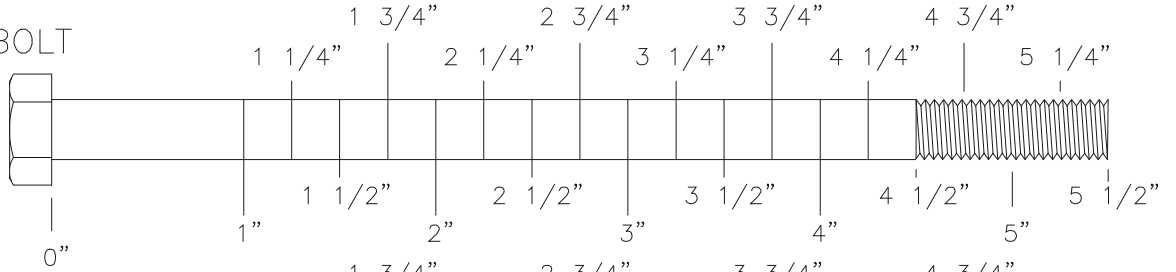
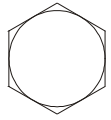

3/8" HEX BOLT

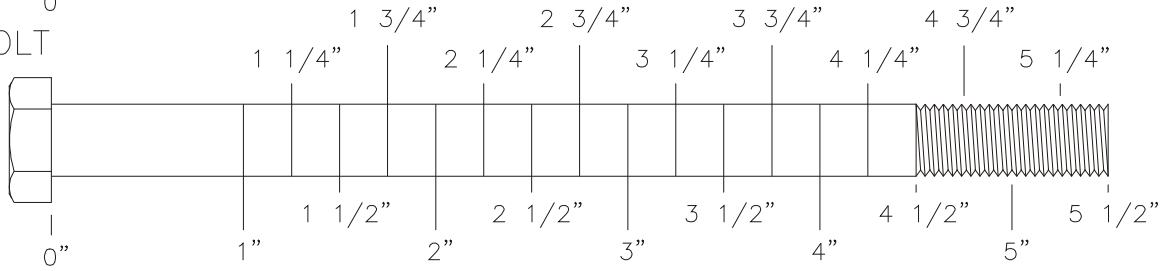
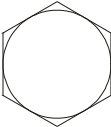

1/2" HEX BOLT

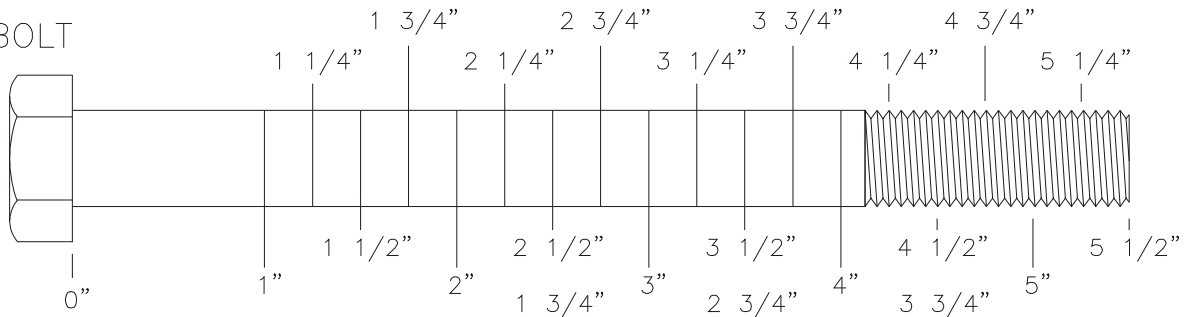
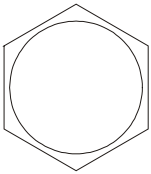

1/2" SHOULDER BOLT

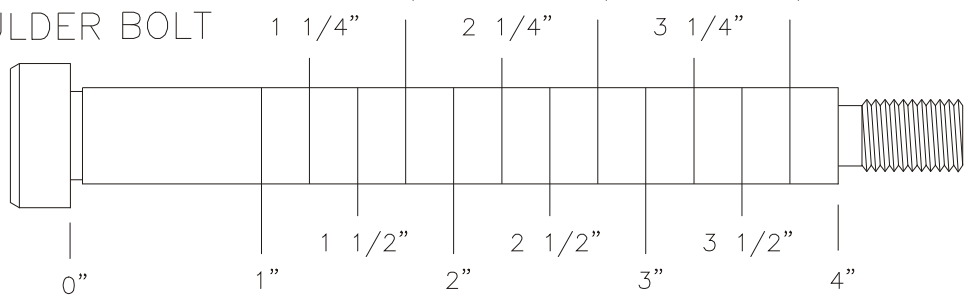
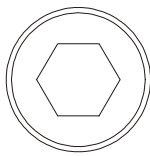

1/4" HEX BOLT

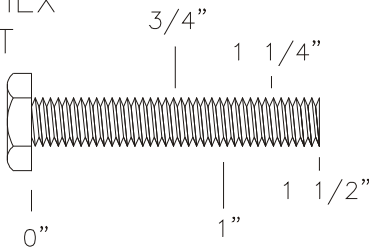
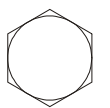

3/8" SOCKET CAP SCREW

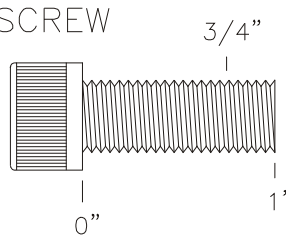
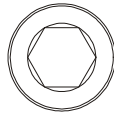

3/8" BUTTON HEAD CAP SCREW

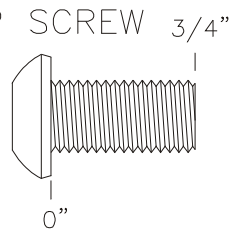
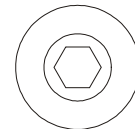

3/8" FLATHEAD SOCKET CAP SCREW

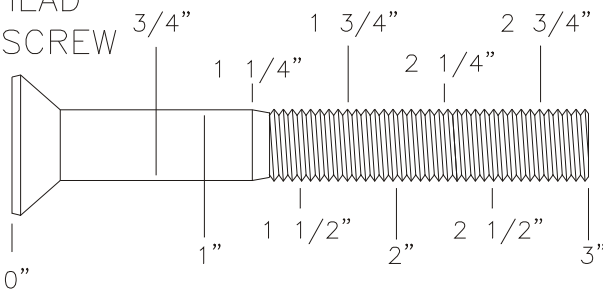
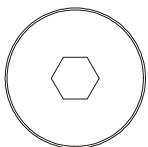

1/2" FLATHEAD SOCKET CAP SCREW

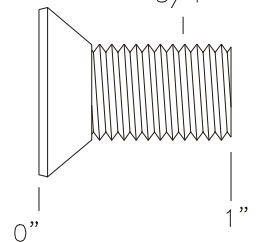
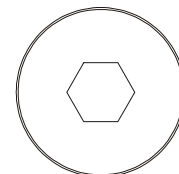

ASSEMBLY

CATALOG

WASHER SIZING CHART

1/4" LONG FLANGED
PULLEY SPACER

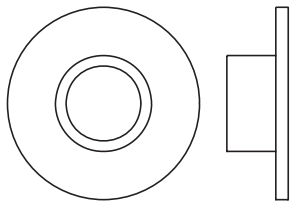

1/2" LONG FLANGED
PULLEY SPACER

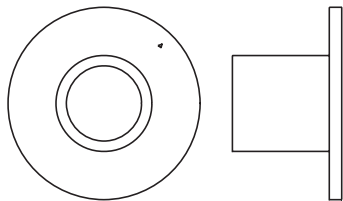

1/2" LONG
PULLEY SPACER

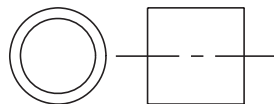

1" LONG
PULLEY SPACER

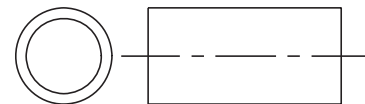

1/4"
LOCK
WASHER



3/8"
LOCK
WASHER

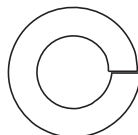

1/2"
LOCK WASHER

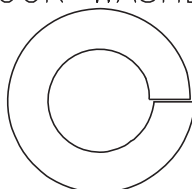

5/16"
FLAT WASHER

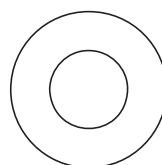

5/16"
FLAT WASHER
LARGE, USS, 25mm

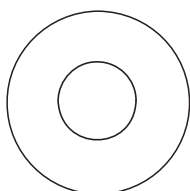

3/8"
FLAT
WASHER

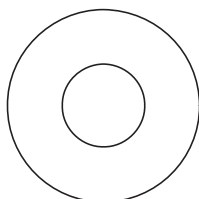

1/2"
FLAT WASHER
SMALL, SAE, 26mm

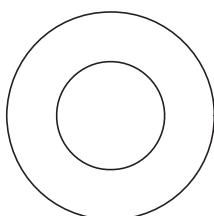

1/2"
FLAT WASHER
LARGE, USS, 34mm

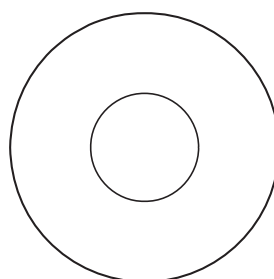

1 3/8" ALUMINUM
FLATHEAD CAP

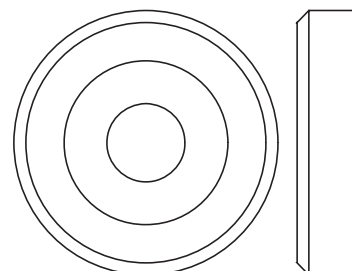

1 5/8" ALUMINUM
FLATHEAD CAP

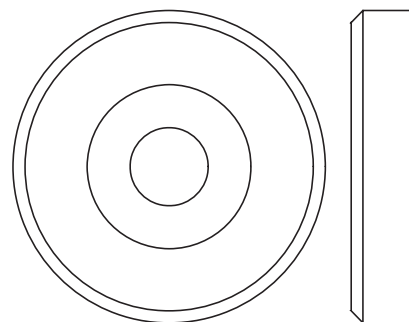

1 1/16"
FENDER WASHER

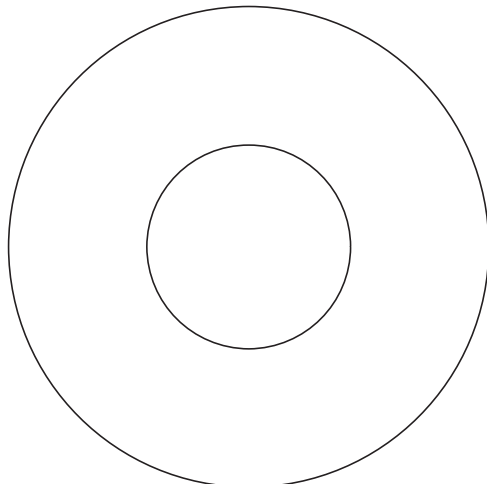

PLASTIC 1 1/16"
FENDER WASHER

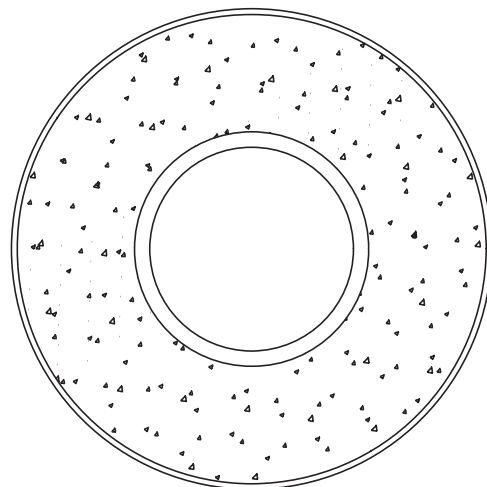

3/8" FENDER WASHER

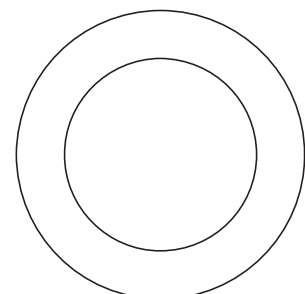
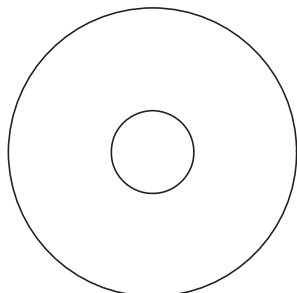

1" SHIM WASHER

ASSEMBLY M A N U A L

MAINTENANCE SCHEDULE

<i>ROUTINE</i>	<i>COMMERCIAL MAINTENANCE</i>	<i>HOME MAINTENANCE</i>	<i>LATEST DATE ENTRY</i>							
Inspect; Links, Pull Pins, Snap Locks, Swivels, Weight Stack Pins	DAILY	WEEKLY								
Clean; Upholstery	DAILY	WEEKLY								
Inspect; Cables or Belts and their tension	DAILY	WEEKLY								
Inspect; Accessory Bars and Handles	WEEKLY	3 MONTHS								
Inspect; All Decals	WEEKLY	3 MONTHS								
Inspect; All Nuts and Bolts, Tighten if Needed	WEEKLY	3 MONTHS								
Inspect; Anti-Skid Surfaces	WEEKLY	3 MONTHS								
Clean & Lubricate; Guide Rods with a Teflon (PTFE) based lubricant (Superlube)	MONTHLY	3 MONTHS								
Lubricate; Seat Sleeves, Turcite Bushings, Linear Bearing	MONTHLY	3 MONTHS								
Clean and Wax; All Glossy Finishes	6 MONTHS	YEARLY								
Repack with Grease; Linear Bearings	6 MONTHS	YEARLY								
Replace; Cables, Belts and Connecting Parts	YEARLY	3 YEARS								

*Your equipment comes with a commercial maintenance decal.
For personal, in home use, please follow the home maintenance schedule listed above.*

ASSEMBLY M A N U A L

HOIST FITNESS SYSTEMS GENERAL MAINTENANCE INFORMATION

Links, Pull-Pins, Snap Locks, Swivels, Weight Stack Pins:

- * *Check all pieces for signs of visible wear or damage.*
- * *Check springs in snap hooks and pull-pins for proper tension and alignment.*
- * *If the spring sticks or has lost its rigidity, replace it immediately.*

Upholstery:

- * *To ensure prolonged upholstery life and proper hygiene, all upholstered pads should be wiped down with a damp cloth after every workout.*
- * *Periodically take the time to use a mild soap or an approved vinyl upholstery cleaner to deter the onset of cracking or drying. Avoid using any abrasive cleaners or cleaners not intended for use on vinyl.*
- * *Replace ripped or worn upholstery immediately.*
- * *Keep sharp or pointed objects clear of all upholstery.*

Guide Rods:

- * *Wipe clean with a dust free rag. Lubricate once a week with a silicon or Teflon based lubricant.*

Decals:

- * *Inspect and familiarized yourself with any safety warnings or other user information posted on each decal.*

Nuts and Bolts:

- * *Inspect all nuts and bolts for any loosening and tighten if needed.*
- * *Go through a re-tightening sequence periodically to ensure that all hardware is tensioned properly.*

Anti-Skid Surfaces:

- * *These surfaces are designed to supply secure footing and need to be replaced if they appear worn or become slippery.*

Cables:

- * *Hoist uses only Aircraft Quality Cable which meets or exceeds military specifications. Although our cables are designed to last for years, to ensure optimum performance and as a routine safety precaution we recommend that all cables be replaced yearly.*
- * *Visually inspect the cable for fraying, cracking, peeling or discoloration.*
- * *While the machine is not in use, carefully run your fingers along the cable to feel for thinning or bulging areas.*
- * *Replace cables immediately at the first signs of damage or wear. Do not use equipment until cables have been replaced.*

ASSEMBLY M A N U A L

Continued: GENERAL MAINTENANCE INFORMATION

Cable Tension:

- * *Referring to the Assembly/Owners Manual, check all cable bolts and attachments to be sure they are properly attached.*
- * *Check slack in cables and readjust cable tension if needed.*

Seat Sleeves, Turcite Bushings:

- * *Wipe down adjusting tubes with a dust free rag before applying lubricant.*
- * *Lubricate seat sleeves and turcite bushings with a silicon or Teflon based lubricant spray.*

Linear Bearings:

- * *Referring to the Assembly/ Owners manual carefully dis-assemble the bearing from its housing and place a finger full of light grease (lithium, super lube, etc.) into the inside of the bearing. Using your finger, press the grease into the ball-bearings and their tracks. Repeat until the ball-bearing tracks are full of grease. Insert the shaft back into the bearing and wipe off excess grease.*

PLEASE KEEP THIS FOR YOUR RECORDS.

ASSEMBLY M A N U A L

HOIST FITNESS SYSTEMS **LIMITED LIFETIME WARRANTY**

Hoist Fitness Systems warrants this product to the **original purchaser** to be free from defects in workmanship and/or materials under normal use or service. If at any time a component part is defective, Hoist Fitness Systems shall repair or replace it (at Hoist Fitness Systems option) within a reasonable period of time. This warranty does not cover costs of removal, transportation or reinstallation. This warranty shall not apply if the defect was caused by misuse, neglect or normal wear and tear.

WARRANTY CLAIMS. All claims require: Model number, Serial number, Date of installation, and any information supporting the existence of the alleged defect.

To complete Warranty Registration visit:
www.HOISTFITNESS.com
and click on the Warranty Registration link

Starting from the original date of purchase, normal wear and tear shall be considered as the following:

COMMERCIAL USE: All malfunctions of upholstery, grips, paint, and chrome that occur after one year; all malfunctions of electronic components, belts, or cables after one year; all malfunctions of pulleys, bearings, or bushings that occur after five years. The frame and all welded components are warranted for the life of the product.

HOME USE: All malfunctions of grips, paint, and chrome that occur after ten years; all malfunctions of electronic components, belts, cables, or upholstery that occur after ten years; all malfunctions of pulleys, bearings, or bushings that occur after ten years. The frame and all welded components are warranted for the life of the product.

PLEASE NOTE THAT NOT ALL HOIST PRODUCTS ARE MADE FOR COMMERCIAL USE.

Refer to the instructions page of your owners manual or consult with you fitness product dealer to establish if a product is made for commercial use or not. Using a non-commercial product in a commercial setting can result in serious injury or death!

Hoist Fitness Systems sole responsibility shall be to repair or replace the component within the terms stated above. Hoist Fitness Systems shall not be liable for any loss or damage of any kind including any incidental or consequential damages resulting, directly or indirectly from any warranty expressed or implied or any other failure of this product.

WHAT IS NOT COVERED BY THIS WARRANTY

Hoist's sole obligation under this warranty is limited to either repair or replacement of parts, subject to the additions below. This warranty neither assumes nor authorizes any person to assume obligations other than expressly covered by this warranty.

NO CONSEQUENTIAL DAMAGES. Hoist is not responsible for economic loss; profit loss; or special, indirect, or consequential damages.

WARRANTY IS NOT TRANSFERABLE. This warranty is not assignable and applies only in favor of the original purchaser/user to whom delivered. Any such assignment or transfer shall void the warranties herein made and shall void all warranties, expressed, implied or statutory, except the one (1) and five (5) year warranties described above. These warranties are exclusive and in lieu of all other warranties, including implied warranty and merchantability or fitness for a particular purpose. There are no warranties which extend beyond the description on the face hereof.

TRANSPORTATION COSTS. Hoist will accept parts covered under this warranty freight collect, provided that shipment has received prior approval. Hoist is not responsible for any other transportation costs, but will ship freight collect parts either repaired or replaced under these warranties.

Hoist Fitness Systems
9990 Empire St. #130
San Diego, CA. 92126
(800)548-5438

PLEASE KEEP THIS FOR YOUR RECORDS