

X1₅ TOTAL-BODY ELLIPTICAL CROSS-TRAINER

USER MANUAL



Life Fitness

CORPORATE HEADQUARTERS

5100 North River Road
Schiller Park, Illinois 60176 • U.S.A.

www.lifefitness.com

INTERNATIONAL OFFICES

LIFE FITNESS ASIA PACIFIC LTD

Room 2610, Miramar Tower
132 Nathan Road
Tsimshatsui, Kowloon
HONG KONG

LIFE FITNESS ATLANTIC BV

LIFE FITNESS BENELUX

Bijdorpplein 25 - 31
2992 LB Barendrecht
THE NETHERLANDS

LIFE FITNESS DO BRAZIL

Av. Dr. Dib Sauaia Neto 1478
Alphaville, Barueri, SP
06465-140
BRAZIL

LIFE FITNESS VERTRIEBS GMBH

Dückergrasse 7-9/3/36
1220 Vienna
AUSTRIA

LIFE FITNESS IBERIA

Pol. Ind. Molí dels Frares. c/C, nº 12
08620 Sant Vicenç dels Horts (Barcelona)
SPAIN

LIFE FITNESS EUROPE GMBH

Siemensstrasse 3
85716 Unterschleissheim
GERMANY

LIFE FITNESS ITALIA S.R.L.

Via Vittorio Veneto, 57/A
39042 Bressanone (Bolzano)
ITALY

LIFE FITNESS LATIN AMERICA and CARIBBEAN

5100 North River Road
Schiller Park, Illinois 60176
U.S.A.

LIFE FITNESS UK LTD

Queen Adelaide
Ely, Cambs CB7 4UB
UNITED KINGDOM

LIFE FITNESS JAPAN

Nippon Brunswick Bldg., #8F
5-27-7 Sendagaya
Shibuya-Ku, Tokyo
JAPAN 151-0051

7824001

05/05

Before using this product, it is essential to read this ENTIRE operation manual and ALL installation instructions.

This will help in setting up the equipment quickly and in instructing others on how to use it correctly and safely.

FCC Warning - Possible Radio / Television Interference

NOTE: *This equipment has been tested and found to comply with the limits for a Class B digital device, pursuant to part 15 of the FCC rules. These limits are designed to provide reasonable protection against harmful interference in a residential installation. This equipment generates, uses and can radiate radio frequency energy, and if not installed and used in accordance with the operation manual, may cause harmful interference to radio communications. However, there is no guarantee that the interference will not occur in a particular installation. If this equipment does cause harmful interference to radio or television reception, which can be determined by turning the equipment off and on, the user is encouraged to try to correct the interference by one or more of the following measures:*

Reorient or relocate the receiving antenna.

Increase the separation between the equipment and the receiver.

Connect the equipment into an outlet on a circuit different from that to which the receiver is connected.

Consult the dealer or an experienced radio/TV technician for help.

Class HB (Home): Domestic use. Not suitable for therapeutic purposes.



CAUTION: Any changes or modifications to this equipment could void the product warranty.

Any service, other than cleaning or user maintenance, must be performed by an authorized service representative. There are no user-serviceable parts.

TABLE OF CONTENTS

- 1. Getting Started6
 - 1.1 Important Safety Instructions6
 - 1.2 Set-up8
 - Where to Place the Cross-trainer // How to Stabilize the Cross-trainer // Plug In the Cross-trainer
- 2 The Display Console9
 - 2.1 The Display Console Overview9
 - 2.2 Display Console Descriptions9
 - 2.3 The Reading Rack and Water Bottle Holder12
 - 2.4 The Wireless Heart Rate Chest Strap13
- 3. Correct Usage13
 - 3.1 Mounting and dismounting the Cross-Trainer13
 - 3.2 Biomechanical Guidelines13
 - General // Forward Motion – Total Body // Reverse Motion – Total Body // Braking Resistance
- 4 The Workouts15
 - 4.1 Workout Overviews15

4.2	Setting Up and Using the Workouts	16
	Selecting and Using Quick Start Manual Mode // Selecting a Workout // Entering a Duration // Selecting and Adjusting the Intensity Level // Starting a Workout // Pausing a Workout // Resetting a Workout // Reviewing a Completed Workout // Understanding the Heart Rate Zone to Maximize Workout Benefits	
4.3	Workout Descriptions	21
4.4	Using the Workouts (Chart)	27
5	Service and Technical Data	28
5.1	Preventative Maintenance Tips	28
5.2	Preventative Maintenance Schedule	29
5.3	How to Obtain Product Service	30
6	Warranty Information	31
7	Cross-trainer Specifications	34

© 2005 Life Fitness, a division of Brunswick Corporation. All rights reserved. Life Fitness is a registered trademark of Brunswick Corporation. Any use of these trademark, without the express written consent of Life Fitness is forbidden.

This Operation Manual describes the functions of the following products:

Life Fitness cross-trainer:

X15

See Section 7, titled *Specifications* page in this manual for product-specific features.

Statement of Purpose: The cross-trainer is an exercise machine that combines low-impact elliptical pedaling with push/pull arm motion to provide an efficient, effective total body workout.



Health-related injuries may result from incorrect or excessive use of exercise equipment. The manufacturer **STRONGLY** recommends seeing a physician for a complete medical exam before undertaking an exercise program, particularly if the user has a family history of high blood pressure or heart disease; or is over the age of 45; or smokes, has high cholesterol, is obese, or has not exercised regularly in the past year. The manufacturer also recommends consulting a fitness professional on the correct use of this product.

If, at any time while exercising, the user experiences faintness, dizziness, pain, or shortness of breath, he or she must stop immediately.

1 GETTING STARTED

1.1 IMPORTANT SAFETY INSTRUCTIONS



SAFETY WARNING: The safety of the product can be maintained only if it is examined regularly for damage and wear. See Preventative Maintenance section for details.

- Before using this product, it is essential to read this ENTIRE operation manual and ALL instructions. The cross-trainer is intended for use solely in the manner described in this manual.
- Always follow the console instructions for proper operation.
- Close supervision is necessary when used by or near children, invalids or disabled persons.
- If the cross-trainer does not function properly after it has been dropped, damaged, or even partially immersed in water, contact Customer Support Services for assistance.
- Never insert objects into any opening in the cross-trainer. If an object should drop inside, carefully retrieve it. If the item is beyond reach, contact Customer Support Services.
- Never place liquids of any type directly on the unit, except in an accessory tray. Containers with lids are recommended.
- Do not use the cross-trainer outdoors, near swimming pools or in areas of high humidity.
- Keep all loose clothing, shoelaces, and towels away from the cross-trainer pedals.
- Keep the area around the cross-trainer clear of any obstructions, including walls and furniture.
- Use caution when mounting or dismounting the cross-trainer. While exercising, always hold onto the user arms.
- Never operate a Life Fitness product if it has a damaged power cord or electrical plug, or if it has been dropped, damaged, or even partially immersed in water. Contact Life Fitness Customer Support Services.

- Keep the power cord away from heated surfaces. Do not pull the equipment by the power cord or use the cord as a handle.
- Do not run the power cord on the floor under or alongside of the Cross-Trainer.
- Wear shoes with rubber or high-traction soles. Do not use shoes with heels, leather soles, cleats or spikes. Do not use the cross-trainer in bare feet.
- Do not tip the cross-trainer on its side during operation.
- Keep hands and feet away from all moving parts.
- To ensure proper functioning of this product, do not install attachments or accessories that are not provided or recommended by Life Fitness.
- Use this product in a well-ventilated area.
- Use this product on a solid, level surface.
- Make sure that all components are fastened securely.

SAVE THESE INSTRUCTIONS FOR FUTURE REFERENCE.

1.2 SETUP

Read the entire Operation Manual before setting up the cross-trainer.

WHERE TO PLACE THE CROSS-TRAINER

Following all safety instructions in Section 1.1, move the cross-trainer to the location in which it will be used. See Section 5, titled *Specifications*, for the dimensions of the footprint. Allow one foot (30.4 cm) of clearance in front of the cross-trainer to allow for movement of the pedal levers. It should be easy to mount the cross-trainer from the side.

HOW TO STABILIZE THE CROSS-TRAINER

After placing the cross-trainer in position, check the unit's stability by attempting to rock it in all directions. Any slight rocking indicates that the unit must be leveled. Determine which foot is not resting completely on the floor. Loosen the jam nut (A) with an open-end 17mm wrench, and rotate the stabilizing foot (B) to lower it. Verify that the cross-trainer is stable, and repeat the adjustment as necessary until the unit no longer rocks. Lock the adjustment by tightening the jam nut against the stabilizer bar. It is extremely important that the stabilizing leg be correctly adjusted for proper operation.

PLUG IN THE CROSS-TRAINER

The cross-trainer comes with a standard power supply for the U.S., or a power supply with country-specific line cords.

Insert the power adapter jack (C) into the barrel plug on the back of the cross-trainer. Then insert the power supply into the wall outlet. Make sure the cord is routed so that it doesn't bind and will not be walked on.

Check that the console LEDs light up. If not, recheck the plug and wall connections and make sure the wall outlet has power.

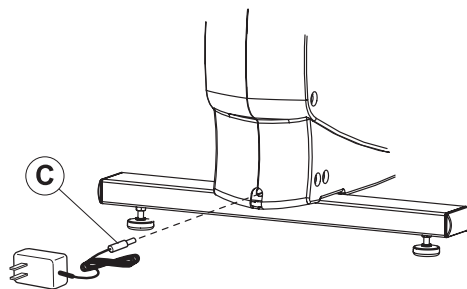
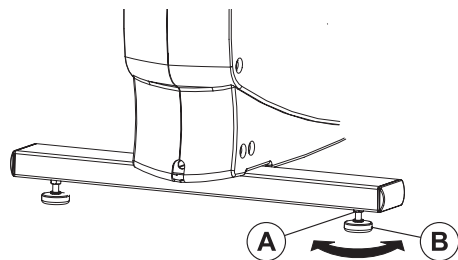

2 THE DISPLAY CONSOLE

2.1 DISPLAY CONSOLE OVERVIEW

The computerized display console on the cross-trainer allows the user to tailor a workout to personal fitness abilities and goals and to monitor progress. With this easy-to-use console the user can track fitness improvement from one workout to the next.

2.2 DISPLAY CONSOLE DESCRIPTIONS

The functions for the keys and display windows on the cross-trainer console are listed and described in this section. See Section 4, titled *The Workouts*, for detailed information on using the console to set up workouts.

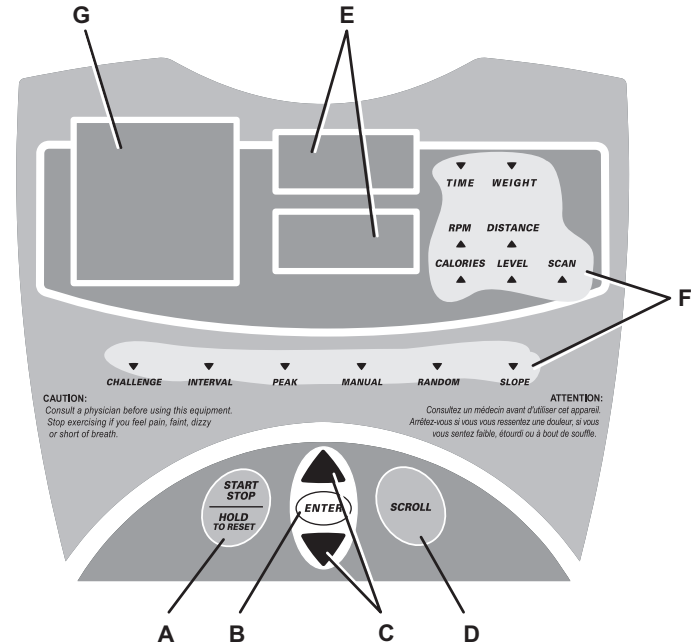

- A START/STOP/HOLD TO RESET:** Use this key to initiate a number of different functions on the cross-trainer.
- Beginning a 30-minute QUICK-START **MANUAL** workout immediately, without setup steps
 - Beginning a workout after completing the setup steps for a specific workout
 - Pausing a workout-in-progress
 - Restarting a paused workout
 - Deleting a current workout and making it possible to set up a new workout
- B ENTER:** Press this key to accept information displayed by the console when setting up a workout.
- C ARROW KEYS:** Use these keys when setting up a workout to change displayed values for workout type, duration, weight and resistance level. When a workout is in progress, use these keys to change the intensity level.
- D SCROLL:** During a workout-in-progress, press this key to browse through workout statistics displayed in the bottom data window. Each time the SCROLL key is pressed, a different value is displayed, and it's corresponding light emitting diode (LED) lights up simultaneously. When the **Scan** LED lights up, the lower DATA window automatically displays all statistics in rotating succession.

Press this key to view summary data for a completed workout, including total calories burned and total distance traveled

- E DATA WINDOWS:** Two data windows are set in the center of the console display.

The top window displays the following statistics. Depending on which statistic is being displayed at any given instance, the corresponding LED lights up at the same time.

- **Time:** The elapsed **time** of a workout-in-progress. During a workout setup, this window also shows the default duration of 30 minutes, which the user can change using the ARROW keys.
- **Weight:** The user's selected weight.

The bottom window displays the following statistics in alternating rotation for a workout-in-progress. Depending on which statistic is being displayed at any given instance, the corresponding LED lights up at the same time.

- **RPM (Revolutions Per Minute):** The pedaling speed or rate
- **Distance:** The total distance traveled
- **Calories:** The number of calories burned
- **Level:** The level of a workout-in-progress

F **WORKOUT LED INDICATORS:** One set of LEDs is matched to the cross-trainer's set of workout options. During a workout setup, each time the user presses an ARROW key to view another workout option, one of these LEDs lights up to indicate that the corresponding workout is the currently displayed option. During a workout-in-progress, the LED corresponding to that workout remains lit.

Another set of LEDs is matched to a set of workout statistics. See the DATA WINDOWS description above.

The LED labeled "scan" lights up during a workout-in-progress to indicate that the console is alternately displaying **RPM, Distance, Calories** and **Level** in the bottom DATA WINDOW.

See the SCROLL key and DATA WINDOW descriptions above for more information.

G **DOT MATRIX DISPLAY:** This window displays a workout's profile, which consists of columns of light that represent the levels of intensity of each interval.

2.3 THE READING RACK AND WATER BOTTLE HOLDER

A reading rack (A) for supporting a book or magazine is located at the base of the upper panel of the console.

A water bottle holder (B) is mounted on the monocolumn of the cross-trainer.

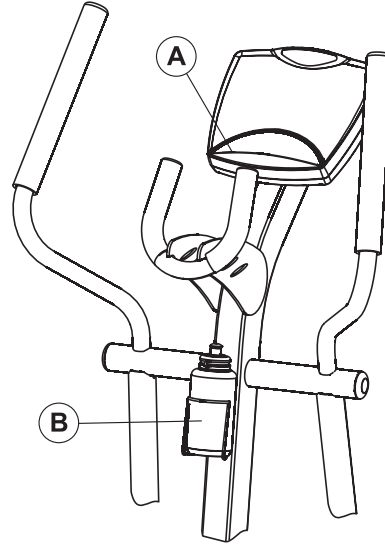

3 CORRECT USAGE

3.1 MOUNTING AND DISMOUNTING THE CROSS-TRAINER

If mounting from the user right side of the Cross-Trainer, grasp the user right handlebar with the right hand. Place the right foot on the user right pedal and carefully step over the Cross-Trainer, grasp the user left handlebar with the left hand, and place the left foot on the user left pedal. If mounting from the user left side, proceed in an opposite fashion. Reverse the process to dismount the Cross-Trainer.

3.2 BIOMECHANICAL GUIDELINES

There are two exercise variations that can be performed on the Cross-Trainer. For each variation, it is important to follow these general biomechanical guidelines as well as the specific instructions listed below.

GENERAL

- Feet should be in a comfortable position facing forward on the pedals so the knees move in a forward plane (not angled inward or outward) and so the hips do not rotate outward.
- Keep back straight. Do not bend forward at the waist.
- Keep both feet on the pedals at all times.
- If desired, allow heels to slightly lift off the pedals during the motion.
- Do not lock knees during the workout. Keep them slightly bent throughout the motion.

FORWARD MOTION – TOTAL BODY

- Mount the Cross-Trainer facing forward
- Hands should be positioned comfortably on the moving handles such that the elbow creates a 90 degree angle when the moving handlebar is rotated toward you
- Choose the desired workout profile and duration on the console
- Begin moving feet in a smooth forward pedaling motion by pushing top foot forward and pulling bottom foot backward
- Exercise at a speed that is comfortable for you

REVERSE MOTION – TOTAL BODY

- Mount the Cross-Trainer facing forward
- Hands should be positioned comfortably on the moving handles such that the elbow creates a 90 degree angle when the moving handlebar is rotated toward you
- Choose the desired workout profile and duration on the console
- Begin moving feet in a smooth reverse pedaling motion by pulling top foot backward and pushing bottom foot forward
- Exercise at a speed that is comfortable for you

BRAKING RESISTANCE

The Life Fitness Cross-Trainer features speed-dependent braking resistance. For a set resistance level on the monitor, the resistance increases with speed. The faster you go, the greater the resistance. The computer makes no adjustments to maintain the resistance level based on your speed.

4 THE WORKOUTS

4.1 WORKOUT OVERVIEWS

This section lists the cross-trainer's pre-programmed workouts. For more detailed information, see Section 4.2, titled *Setting Up and Using the Workouts*.

QUICK START MANUAL MODE is the fastest way to begin exercising, and it bypasses the steps involved in selecting a specific workout program. After the START key is pressed, a constant-level workout begins. The resistance level does not change automatically.

INTERVAL combines "hills" and "valleys" of different resistance levels, which is proven to provide effective, time-efficient cardiovascular results.

RANDOM is an interval training workout for which the user selects a computer-generated profile of varying intensity levels.

MANUAL is a workout in which the resistance level does not change automatically.

PEAK is intended to burn fat by building up to, and maintaining, a constant level of resistance throughout the workout.

SLOPE gradually increases the intensity throughout the workout duration. It is intended to strengthen the heart, as well as the major muscle groups that are most active during the workout, such as the leg muscle groups.

CHALLENGE begins at a high resistance level and maintains this level throughout the duration.

4.2 SETTING UP AND USING THE WORKOUTS

To activate the console, press any key, or simply start pedaling. When the console display lights up, either select **QUICK START MANUAL MODE**, or select a specific workout. Setting up a specific workout involves five steps, which are described in this section:

1. Selecting a workout
2. Entering a workout duration
3. Entering a weight
4. Selecting a level
5. Starting the workout (pressing **START**) or **ENTER**

SELECTING AND USING QUICK START MANUAL MODE

Press the **START** key to begin a 30-minute **MANUAL** workout immediately. Once the workout is in progress, it is possible to change the resistance level using the **ARROW** keys.

SELECTING A WORKOUT

Press the **ARROW KEYS** until the LED display for the desired workout lights up. Then, press **ENTER** to confirm the workout selection.

ENTERING A WORKOUT DURATION

After a workout is selected, the top **DATA WINDOW** flashes a default workout duration of 30 minutes. Press **ENTER** to accept the default. Or, to change the duration, use the **ARROW** keys. Then, when the desired duration appears in the **DATA WINDOW**, press **ENTER** to accept the duration. It is not possible to change the duration of a workout-in-progress.

ENTERING A WEIGHT

After a workout is selected, the top DATA WINDOW flashes a default weight. Press ENTER to accept the default. Or, to change the weight, use the ARROW keys. Then, when the weight appears in the DATA WINDOW, press ENTER to accept it. The on-board computer calculates the number and rate of calories burned using the entered weight as well as the pedaling speed.

SELECTING A LEVEL FOR A MANUAL WORKOUT

After a duration is entered, the bottom DATA WINDOW flashes a default resistance level of “1”, which is the easiest of the 16 resistance levels. Press ENTER to accept the default. Or, to change the level, use the ARROW keys. Then, when the desired level appears in the DATA WINDOW, press ENTER to accept the duration. While the workout is in progress, it is possible to change the resistance level (1-16).

NOTE: *QuickStart and Manual Workouts have 1 - 16 resistance levels.*

SELECTING A LEVEL FOR RANDOM, INTERVAL, SLOPE, PEAK, AND CHALLENGE WORKOUTS

After a duration is entered, the bottom DATA WINDOW flashes a default level of “1,” which is the easiest of the 9 difficulty levels. Press ENTER to accept the default. Or, to change the level, use the ARROW keys. Then, when the desired level appears in the DATA WINDOW, press ENTER to accept the duration. While the workout is in progress, it is possible to change the difficulty level.

NOTE: *Random, Interval, Slope, Peak, and Challenge workouts have 1 - 9 levels.*

DIFFICULTY LEVEL TABLE (APPLIES TO RANDOM, INTERVAL, SLOPE, PEAK, CHALLENGE)

Program Difficulty Level	Resistance Level Range
1	1 to 8
2	2 to 9
3	3 to 10
4	4 to 11
5	5 to 12
6	6 to 13
7	7 to 14
8	8 to 15
9	9 to 16

EXPLANATION OF DIFFICULTY LEVELS

The difficulty level table shows the resistance level range at each difficulty level. Since some workouts have predetermined profiles, a resistance level range had to be created. This allows the user to set a difficulty level of 1 - 9, which will adjust the entire workouts intensity level.

STARTING A WORKOUT

After accepting a level, press START to begin the workout.

USING WORKOUTS IN PROGRESS

The cross-trainer MANUAL program features 16 resistance levels, with “1” being the easiest and “16” being the most difficult. The cross-trainer RANDOM, SLOPE, INTERVAL, PEAK, and CHALLENGE programs feature 9 difficulty levels, with “1” being the easiest and “9” being the most difficult. While a workout is in progress, it is possible to change the level of the overall workout. To do so, simply press the UP or DOWN arrow keys repeatedly until the DATA DISPLAY window shows the desired level. That change remains in effect for the entire workout or until the level is changed again.

NOTE: *The cross-trainer features speed-dependent braking resistance. For a set resistance level on the monitor, the resistance increases with the user’s speed. The computer makes no adjustments to maintain the resistance level based on the user’s speed.*

PAUSING A WORKOUT

To pause a workout-in-progress, press the STOP key, or simply stop pedaling for 25 seconds. A workout can remain in pause mode for a maximum duration of five minutes. If a paused workout is not resumed before the five-minute pause duration ends, the console shuts down, and the paused workout information is lost. To resume a paused workout, press the START key or simply begin pedaling again.

RESETTING A WORKOUT

To reset a workout, press the STOP key, and hold it for three seconds. This deletes the current workout and makes it possible to set up a new workout.

REVIEWING A COMPLETED WORKOUT

When a workout reaches the end of its duration, the console emits four consecutive beeps. At this point, it is possible to review summary data for the completed workout, including total calories burned and distance traveled, by pressing the SCROLL key and reading the results in the DATA WINDOWS. Afterward, press the STOP key to return to the workout-select mode.

USING THE HEART RATE ZONE TO MAXIMIZE WORKOUT BENEFITS

Research shows that keeping the heart rate within a certain range while exercising promotes muscular and cardiovascular conditioning for maximum health benefits. This range is between 60 percent and 85 percent of a given user's theoretical maximum heart rate. The maximum rate varies by age. To calculate it, subtract the user's age from the number 220.

For example, the theoretical maximum heart rate for a 35-year-old user would be 185 beats per minute (bpm) because $220 - 35 = 185$. Therefore, the optimal heart rate range or zone for a 35-year-old user would be between 111 bpm ($185 \times .60$) and 157 bpm ($185 \times .85$).

NOTE: *Consulting a fitness trainer is recommended for defining specific fitness goals and designing a workout program.*

To monitor the heart rate during a workout, feel the pulse in the wrist or the carotid artery in the neck while looking at a watch. Count the number of pulse beats within one minute.

SWITCHING THE CONSOLE DISPLAY TO METRIC UNITS

By default, the cross-trainer's console displays the workout statistic of distance in English units. It is possible to switch to metric units. When the console is shut down, remove the four screws that attach the console to the console support assembly column. Carefully turn the console upside down and flip the "English/Metric" switch that appears in the back of the console to the "Metric" setting. Re-attach the console to the support assembly column. Restart the cross-trainer.

4.3 WORKOUT DESCRIPTIONS

MANUAL

PURPOSE OF MANUAL WORKOUT

Allows the user to be in complete control of the resistance level. The level directly corresponds with the braking system. So if the user sets the level to 9, then the braking resistance is set to 9.

EXPLANATION OF TIME SEGMENTS

The workout has 20 total time segments displayed in the shape of a racetrack. The first time segment is located in the lower left corner of the racetrack. The current time segment will blink to help display the amount of time left in the workout.

EXPLANATION OF RESISTANCE LEVEL

Manual is the only workout where the levels are the actual resistance levels of the eddy current brake. The resistance level is displayed in the first column. There are 1 - 16 resistance levels to choose from. Each LED light in the column represents 2 levels. The below resistance level column is either at level 7 or 8. The resistance can be adjusted from 1 - 16 at any time during the workout by pressing the UP and DOWN ARROW keys.

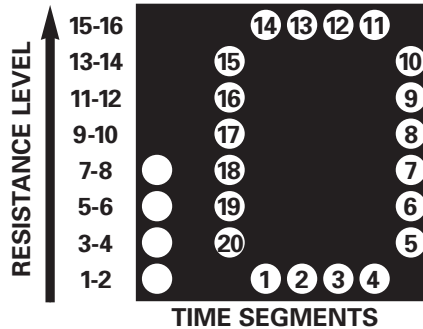

PEAK

PURPOSE OF PEAK WORKOUT

Maintains a constant resistance level throughout the workout. Intended to burn fat.

EXPLANATION OF TIME SEGMENTS

The workout has 16 total time segments, although the workout profile window can only display 8 segments at a time. The workout profile begins by displaying the first half of the workout, or 1 - 8 time segments. Once the eighth time segment is completed, the final 9 - 16 segments will be displayed. The current workout time segment will blink to show the active interval.

EXPLANATION OF SEGMENT DIFFICULTY LEVEL

The segment difficulty level is predetermined and will always be displayed as shown below.

EXPLANATION OF OVERALL WORKOUT DIFFICULTY LEVEL

During a workout, the overall workout difficult level can be adjusted. There are 1 - 9 program difficulty levels and each has a corresponding resistance level range. See difficulty level table for reference. When the overall difficulty level is adjusted, there will be no visual change to the workout profile display.

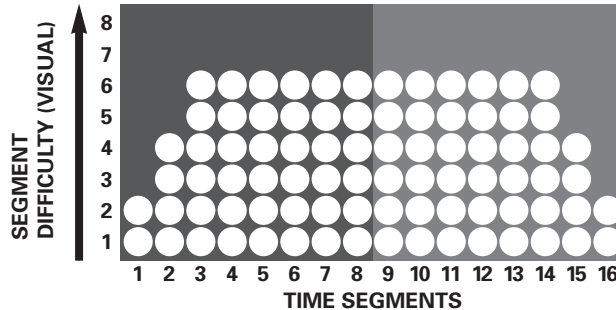

RANDOM

PURPOSE OF RANDOM WORKOUT

Provides a completely random workout profile of hills and valleys every time the user selects this workout. Endless variety reduces boredom.

EXPLANATION OF TIME SEGMENTS

The workout has 16 total time segments, although the workout profile window can only display 8 segments at a time. The workout profile begins by displaying the first half of the workout, or 1 - 8 time segments. Once the eighth time segment is completed, the final 9 - 16 segments will be displayed. The current workout time segment will blink to show the active interval.

EXPLANATION OF SEGMENT DIFFICULTY LEVEL

The segment difficulty level is predetermined and will always be displayed as shown below.

EXPLANATION OF OVERALL WORKOUT DIFFICULTY LEVEL

During a workout, the overall workout difficult level can be adjusted. There are 1 - 9 program difficulty levels and each has a corresponding resistance level range. See difficulty level table for reference. When the overall difficulty level is adjusted, there will be no visual change to the workout profile display.

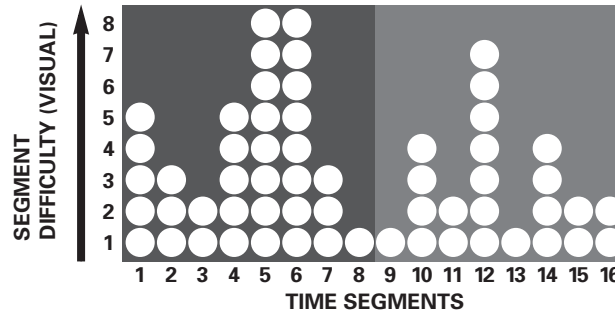

SLOPE

PURPOSE OF SLOPE WORKOUT

Gradually increases resistance so user is less aware of the physical demand. Helps user slowly build-up to higher resistance levels and improve cardiovascular endurance.

EXPLANATION OF TIME SEGMENTS

The workout has 16 total time segments, although the workout profile window can only display 8 segments at a time. The workout profile begins by displaying the first half of the workout, or 1 - 8 time segments. Once the eighth time segment is completed, the final 9 - 16 segments will be displayed. The current workout time segment will blink to show the active interval.

EXPLANATION OF SEGMENT DIFFICULTY LEVEL

The segment difficulty level is predetermined and will always be displayed as shown below.

EXPLANATION OF OVERALL WORKOUT DIFFICULTY LEVEL

During a workout, the overall workout difficult level can be adjusted. There are 1 - 9 program difficulty levels and each has a corresponding resistance level range. See difficulty level table for reference. When the overall difficulty level is adjusted, there will be no visual change to the workout profile display.

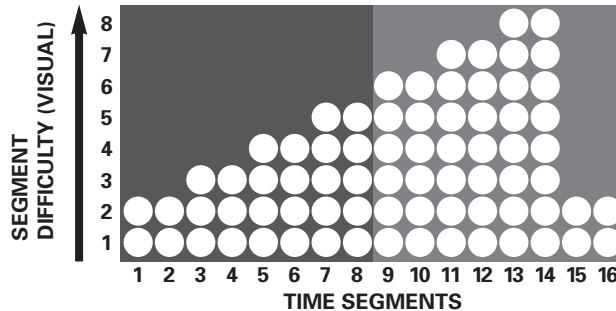

INTERVAL

INTERVAL

PURPOSE OF INTERVAL WORKOUT

Combines alternating hills and valleys of high and low resistance levels. Raising and lowering the heart rate in this manner is proven to efficiently promote fat burn and cardiovascular endurance.

EXPLANATION OF TIME SEGMENTS

The workout has 16 total time segments, although the workout profile window can only display 8 segments at a time. The workout profile begins by displaying the first half of the workout, or 1 - 8 time segments. Once the eighth time segment is completed, the final 9 - 16 segments will be displayed. The current workout time segment will blink to show the active interval.

EXPLANATION OF SEGMENT DIFFICULTY LEVEL

The segment difficulty level is predetermined and will always be displayed as shown below.

EXPLANATION OF OVERALL WORKOUT DIFFICULTY LEVEL

During a workout, the overall workout difficult level can be adjusted. There are 1 - 9 program difficulty levels and each has a corresponding resistance level range. See difficulty level table for reference. When the overall difficulty level is adjusted, there will be no visual change to the workout profile display.

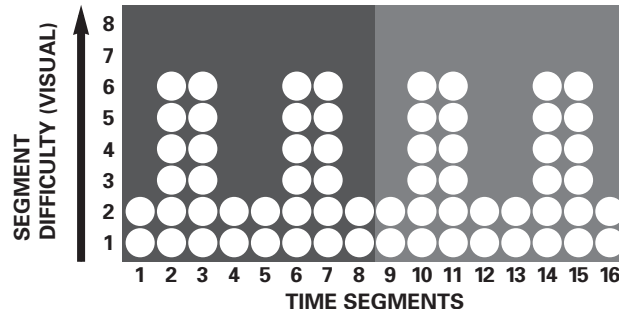

CHALLENGE

PURPOSE OF CHALLENGE WORKOUT

Maintains a high resistance level throughout the workout. Challenges the user to a high intensity workout that promotes cardiovascular endurance.

EXPLANATION OF TIME SEGMENTS

The workout has 16 total time segments, although the workout profile window can only display 8 segments at a time. The workout profile begins by displaying the first half of the workout, or 1 - 8 time segments. Once the eighth time segment is completed, the final 9 - 16 segments will be displayed. The current workout time segment will blink to show the active interval.

EXPLANATION OF SEGMENT DIFFICULTY LEVEL

The segment difficulty level is predetermined and will always be displayed as shown below.

EXPLANATION OF OVERALL WORKOUT DIFFICULTY LEVEL

During a workout, the overall workout difficulty level can be adjusted. There are 1 - 9 program difficulty levels and each has a corresponding resistance level range. See difficulty level table for reference. When the overall difficulty level is adjusted, there will be no visual change to the workout profile display.

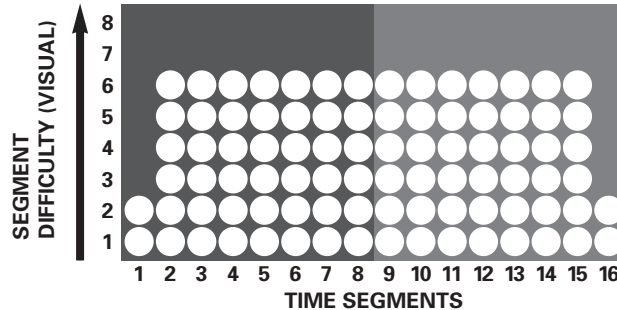

4.4 USING THE WORKOUTS (CHART)

The following charts will help you set up and begin the various workout programs. First, select a workout using the specific workout key. Then, use the Arrows to enter data as prompted. The display will prompt for any additional information that may be needed for the new workout.

WORKOUT SELECTIONS

MANUAL

Enter time
Enter weight
Enter level
Begin workout

PEAK

Enter time
Enter weight
Enter level
Begin workout

RANDOM

Enter time
Enter weight
Enter level
Begin workout

SLOPE

Enter time
Enter weight
Enter level
Begin workout

INTERVAL

Enter time
Enter weight
Enter level
Begin workout

CHALLENGE

Enter time
Enter weight
Enter level
Begin workout

5 SERVICE AND TECHNICAL DATA

5.1 PREVENTATIVE MAINTENANCE TIPS

The cross-trainer is backed by engineering excellence and is one of the most rugged and trouble-free pieces of exercise equipment on the market today. The manufacturer's products have proven to be durable in health clubs, colleges, military facilities, and other locations the world over. This same technology, engineering expertise, and reliability have gone into the cross-trainer.

NOTE: *The safety of the equipment can be maintained only if the equipment is examined regularly for damage or wear. If maintenance is required, keep the equipment out of use until defective parts are repaired or replaced. Pay special attention to parts that are subject to wear as outlined in the Preventive Maintenance Schedule.*

The following preventive maintenance tips will keep the cross-trainer operating at peak performance:

- Locate the cross-trainer in a cool, dry place.
- Clean the top surface of the pedals regularly.
- Keep the display console free of fingerprints and salt build-up caused by sweat.
- Use a **100% cotton cloth**, lightly moistened with water and a mild liquid cleaning product, to clean the cross-trainer. Other fabrics, including paper towels, may scratch the surface. **Do not use ammonia or acid-based cleaners.**
- Long fingernails may damage or scratch the surface of the console; use the pad of the finger to press the selection buttons on the console.
- Clean the housing thoroughly on a regular basis.

NOTE: *A non-abrasive cleaner and soft cotton cloth are strongly recommended for cleaning the exterior of the unit. At no time should cleaner be applied directly to any part of the equipment; apply the non-abrasive cleaner on a soft cloth, and then wipe the unit.*

5.2 PREVENTATIVE MAINTENANCE SCHEDULE

Follow the schedule below to ensure proper operation of the product.

<i>ITEM</i>	<i>WEEKLY</i>	<i>MONTHLY</i>	<i>BI-ANNUALLY</i>	<i>ANNUALLY</i>
<i>Display Console</i>	<i>C</i>	<i>I</i>		
<i>Console Mounting Bolts</i>			<i>I</i>	
<i>Frame</i>	<i>C</i>			<i>I</i>
<i>Plastic Covers</i>	<i>C</i>	<i>I</i>		

KEY: C=Clean; I=Inspect

5.3 HOW TO OBTAIN PRODUCT SERVICE

1. Verify the symptom and review the operating instructions. The problem may be unfamiliarity with the product and its features and workouts.
2. Locate and document the serial number of the unit. The serial number plate is located on the front stabilizer, below the shroud.
3. Contact Customer Support Services via the Web at: www.lifefitness.com, or call the nearest Customer Support Services group:

For Product Service within
the United States and Canada:

Telephone: (+1) 847.451.0036
FAX: (+1) 847.288.3702
Toll-free telephone: 800.351.3737

For Product Service
Internationally:

Life Fitness Europe GmbH

Telephone: (+49) 089.317.751.66
FAX: (+49) 089.317.751.38

Life Fitness (UK) LTD

Telephone: (+44) 1353.665507
FAX: (+44) 1353.666018

Life Fitness Atlantic BV

Life Fitness Benelux
Telephone: +31 (0) 180 64 66 66
FAX: +31 (0) 180 64 66 99

Life Fitness Italia S.R.L.

Telephone: (+39) 0472.835.470
FAX: (+39) 0472.833.150
Toll-free telephone: 800.438836

Life Fitness Vertriebs GmbH

Telephone: (+43) 1615.7198
FAX: (+43) 1615.7198.20

Life Fitness Asia Pacific Ltd

Telephone: (+852) 2891.6677
FAX: (+852) 2575.6001

*Life Fitness Latin America
and Caribbean*

Telephone: (+1) 847.288.3964
FAX: (+1) 847 288.3886

Life Fitness Brazil

Telephone: (+55) 11.7295.2217
FAX: (+55) 11.7295.2218

Life Fitness Japan

Telephone: (+81) 3.3359.4306
FAX: (+81) 3.3359.4307

Life Fitness Iberia

Telephone : (+34) 93 672 4660
FAX : (+34) 93 672 4670

6 WARRANTY INFORMATION

WHAT IS COVERED:

This Life Fitness consumer product ("Product") is warranted to be free of all defects in material and workmanship.

WHO IS COVERED:

The original purchaser or any person receiving a newly purchased Product as a gift from the original purchaser.

HOW LONG IS IT COVERED:

Residential: All electrical and mechanical components and labor are covered, after the date of purchase, as listed on the chart at the end of this section.

Non-Residential: Warranty void (this Product is intended for residential use only).

WHO PAYS SHIPPING & INSURANCE FOR SERVICE:

If the Product or any warranted part must be returned to a service facility for repairs, Life Fitness will pay all shipping and insurance charges during the warranty period (within the United States only). The purchaser is responsible for shipping and insurance charges after the warranty has expired.

WHAT WE WILL DO TO CORRECT COVERED DEFECTS:

We will ship to you any new or rebuilt replacement part or component, or, at our option, replace the Product. Such replacement parts are warranted for the remaining portion of the original warranty period.

WHAT IS NOT COVERED:

Any failures or damage caused by unauthorized service, misuse, accident, negligence, improper assembly or installation, debris resulting from any construction activities in the Product's environment, rust or corrosion as a result of the Product's location, alterations or modifications without our written authorization or by failure on your part to use, operate and maintain the Product as set out in your User Manual ("Manual"). All terms of this warranty are void if this Product is moved beyond the continental borders of the United States of America (excluding Alaska, Hawaii and Canada) and are then subject to the terms provided by that country's local authorized Life Fitness Representative.

WHAT YOU MUST DO:

Retain proof of purchase (our receipt of the attached registration card assures registration of purchase information but is not required); use, operate and maintain the Product as specified in the Manual; notify Customer Service of any defect within 10 days after discovery of the defect; if instructed, return any defective part for replacement or, if necessary, the entire Product for repair. Life Fitness reserves the right to decide whether or not a product is to be returned for repair.

USER MANUAL:

It is VERY IMPORTANT THAT YOU READ THE MANUAL before operating the Product. Remember to perform the periodic maintenance requirements specified in the Manual to assure proper operation and your continued satisfaction.

PRODUCT REGISTRATION:

Register online at www.lifefitness.com/registration. Our receipt assures that your name, address and date of purchase are on file as a registered owner of the Product. Failure to return the card will not affect your rights under this warranty. Being a registered owner assures coverage in the event you lose your proof of purchase. Please retain your proof of purchase, such as your bill of sale or receipt.

HOW TO GET PARTS & SERVICE:

Simply call Customer Service at 1-800-351-3737 or (+1) 847-288-3300, Monday through Friday from 8:00 a.m. to 5:00 p.m. Central Standard Time, and tell them your name, address and the serial number of your Product (consoles and frames may have separate serial numbers). They will tell you how to get a replacement part, or, if necessary, arrange for service where your Product is located.

EXCLUSIVE WARRANTY:

THIS LIMITED WARRANTY IS IN LIEU OF ALL OTHER WARRANTIES OF ANY KIND EITHER EXPRESSED OR IMPLIED, INCLUDING BUT NOT LIMITED TO THE IMPLIED WARRANTIES OF MERCHANTABILITY AND FITNESS FOR A PARTICULAR PURPOSE, AND ALL OTHER OBLIGATIONS OR LIABILITIES ON OUR PART. We neither assume nor authorize any person to assure for us any other obligation or liability concerning the sale of this Product. Under no circumstances shall we be liable under this warranty, or otherwise, of any damage to any person or property, including any lost profits or lost savings, for any special, indirect, secondary, incidental or consequential damages of any nature arising out of the use of or inability to use this Product. Some states do not allow the exclusion or limitation of implied warranties or of liability for incidental or consequential damages, so the above limitations or exclusions may not apply to you. Warranties may vary outside the U.S. Contact Life Fitness for details.

CHANGES IN WARRANTY NOT AUTHORIZED:

No one is authorized to change, modify or extend the terms of this limited warranty.

EFFECT OF U.S. STATE LAWS:

This warranty gives you specific legal rights and you may have other rights which vary from state to state.

MODEL	LIFETIME	5 YEARS	3 YEARS	1 YEAR
X15	Frame	N/A	Electrical Parts & Mechanical Parts	Labor

7 SPECIFICATIONS

Designed use:	Consumer
Maximum user weight:	300 pounds / 136 kilograms
Resistance system:	Eddy current
CONSOLE:	
Displays:	DATA DISPLAYS with time, RPM, distance, calories, and level DOT MATRIX WINDOW indicating workout profile
Summaries:	Time, distance
WORKOUTS:	Quick Start Manual Mode, Interval, Random, Manual, Peak, Slope, Challenge
Resistance levels:	16
Pedal size	16 inches by 7 inches / 41 centimeters by 18 centimeters
Drive type:	Link6
Power requirements:	120V in United States 220V in Europe 240+V in Australia
Color:	Pewter Metal Charcoal gray plastics Stone gray accents

ASSEMBLED DIMENSIONS:

Length	65 inches / 165 centimeters
Width	27 inches / 68 centimeters
Height	62 inches / 157 centimeters
Weight	204 pounds / 93 kilograms

SHIPPING DIMENSIONS:

Length	73 inches / 185 centimeters
Width	28.5 inches / 72.5 centimeters
Height	32 inches / 81 centimeters
Weight	244 pounds / 111 kilograms



Life Fitness offers a full line of premier fitness equipment for the home.

TOTAL-BODY ELLIPTICAL CROSS-TRAINERS | TREADMILLS | LIFECYCLE® EXERCISE BIKES
STAIRCLIMBERS | GYM SYSTEMS

5100 N. RIVER ROAD, SCHILLER PARK, ILLINOIS 60176
LIFEFITNESS.COM